



HP PageWide Pro 452 series

User Guide

Copyright and License

© 2016 Copyright HP Development Company, L.P.

All rights reserved. Reproduction, adaptation, or translation of this material is prohibited without prior written permission of HP, except as allowed under copyright laws.

The information contained in this document is subject to change without notice.

The only warranties for HP products and services are set forth in the express warranty statements accompanying such products and services. Nothing herein should be construed as constituting an additional warranty. HP shall not be liable for technical or editorial errors or omissions contained herein.

Edition 1, 2/2016

Trademark Credits

Adobe®, Acrobat®, and PostScript® are trademarks of Adobe Systems Incorporated.

Intel® Core™ is a trademark of Intel Corporation in the U.S. and other countries.

Java™ is a US trademark of Sun Microsystems, Inc.

Microsoft®, Windows®, Windows® XP, and Windows Vista® are U.S. registered trademarks of Microsoft Corporation.

UNIX® is a registered trademark of The Open Group.

ENERGY STAR and the ENERGY STAR mark are registered trademarks owned by the U.S. Environmental Protection Agency.

Table of contents

1 Product basics	1
Product features	2
Environmental features	2
Accessibility features	2
Product views	3
Front view	3
Back view	3
Cartridge door view	4
Power on and off	5
Turn the product on	5
Manage power	5
Turn the product off	6
Use the control panel	7
Control panel menu buttons	7
Control panel menu navigation	8
Control panel action buttons	8
Control panel supply status	8
Help features	9
Printer information	9
Help animations	10
Quiet Mode	10
To turn Quiet Mode on or off from the control panel	10
To turn Quiet Mode on or off from the EWS	10
2 Connect the product	11
Connect the product to a computer or a network	12
To connect the product using a USB cable	12
To connect the product to a network	13
Supported network protocols	13
Connect the product using a wired network	13
Connect the product using a wireless network (wireless models only)	13

To connect the product to a wireless network using the Wireless Setup Wizard	14
To connect the product to a wireless network using WPS	14
To connect the product to a wireless network manually	15
Use Wi-Fi Direct to connect a computer or device to the product	16
To turn on Wi-Fi Direct	16
To print from a wireless-capable mobile device	16
To print from a wireless-capable computer (Windows)	16
To print from a wireless-capable computer (OS X)	16
Install HP printer software for a wireless product already on the network	18
Open the printer software (Windows)	18
Manage network settings	18
View or change network settings	18
Set or change the product password	19
Manually configure TCP/IP parameters from the control panel	19
Link speed and duplex settings	19
3 Printer management and services	21
HP Embedded Web Server	22
About the EWS	22
About cookies	22
Open the EWS	23
Features	23
Home tab	23
Web Services tab	24
Network tab	24
Tools tab	24
Settings tab	25
Web Services	25
What are Web Services?	25
HP ePrint	26
Print apps	26
Set Up Web Services	26
Use Web Services	27
HP ePrint	27
Print apps	28
Remove Web Services	28
HP Web Jetadmin software	29
Product security features	29
Security statements	29
Firewall	29

Security settings	30
Firmware updates	31
HP Printer Assistant in the printer software (Windows)	31
Open the HP Printer Assistant	31
Features	31
Connected tab	31
Print tab	31
Shop tab	32
Help tab	32
Tools tab	32
Estimated Levels tab	32
HP Utility (OS X)	32
AirPrint™ (OS X)	33

4 Paper and print media 34

Understand paper use	35
Supported media sizes	36
Supported paper and print media sizes	36
Supported envelope sizes	37
Supported card and label sizes	37
Supported photo media sizes	37
Supported paper types and tray capacity	38
Tray 1 (multipurpose) on left side of the product	38
Tray 2 (default tray)	39
Configure trays	39
Load media	40
Load Tray 1	40
Load Tray 2	41
Load envelopes	42
Load letterhead or preprinted forms	44
Tips for selecting and using paper	46

5 Cartridges 47

HP PageWide cartridges	48
HP policy on non-HP cartridges	48
Counterfeit HP cartridges	48
Manage cartridges	48
Store cartridges	49
Print with General Office mode	49
Print when a cartridge is at estimated end of life	49
Check the estimated cartridge levels	49

Order cartridges	50
Recycle cartridges	51
Replace cartridges	51
Tips for working with cartridges	53
6 Print	54
Print from a computer	55
To print from a computer (Windows)	55
To print from a computer (OS X)	56
To set up printing shortcuts (Windows)	57
To set up printing presets (OS X)	57
To adjust or manage colors	58
Choose a preset color theme for a print job	58
Adjust the color options for a print job manually	58
Match colors to your computer screen	59
Control access to color printing	59
Print with HP ePrint	60
Print off site by sending an email with the HP ePrint app	60
Print from an on-site computer or mobile device	60
Print with AirPrint (OS X)	60
Tips for print success	62
Cartridge tips	62
Paper loading tips	62
Printer settings tips (Windows)	62
Printer settings tips (OS X)	63
7 Solve problems	64
Problem-solving checklist	65
Check that the product power is on	65
Check the control panel for error messages	65
Test print functionality	65
Try sending a print job from a computer	65
Factors that affect product performance	65
Information pages	66
Factory-set defaults	67
Cleaning routines	67
Clean the printhead	67
Clean the touch screen	68
Jams and paper-feed issues	69
The product does not pick up paper	69
The product picks up multiple sheets of paper	69

Prevent paper jams	69
Clear jams	70
Jam locations	70
Clear jams in Tray 1 (multipurpose tray)	70
Clear jams in Tray 2	71
Clear jams in the left door	72
Clear jams in the output bin	72
Clear jams in the duplexer	73
Cartridge issues	74
Refilled or remanufactured cartridges	74
Interpret control panel messages for cartridges	75
Cartridge Depleted	75
Cartridge Low	75
Cartridge Very Low	75
Counterfeit or used [color] cartridge installed	75
Do not use SETUP cartridges	75
Genuine HP cartridge installed	75
Incompatible [color]	76
Incompatible cartridges	76
Install [color] cartridge	76
Non-HP cartridges installed	76
Printer Failure	77
Problem with Print System	77
Problem with Printer Preparation	77
Problem with SETUP cartridges	77
Use SETUP cartridges	77
Used [color] installed	78
Printing issues	78
The product does not print	78
The product prints slowly	79
Improve print quality	79
Check for genuine HP cartridges	79
Use paper that meets HP specifications	79
Use the correct paper type setting in the printer driver	80
Change the paper type and size setting (Windows)	80
Change the paper type and size setting (OS X)	80
Use the printer driver that best meets your printing needs	80
Align the printhead	81
Print a print-quality report	81
Connectivity issues	81
Solve USB direct-connect problems	81

Solve network problems	82
Poor physical connection	82
The computer is using the incorrect IP address for the product	82
The computer is unable to communicate with the product	82
The product is using incorrect link and duplex settings for the network	83
New software programs might be causing compatibility problems	83
The computer or workstation might be set up incorrectly	83
The product is disabled, or other network settings are incorrect	83
Wireless network issues	83
Wireless connectivity checklist	83
The product does not print, and the computer has a third-party firewall installed	84
The wireless connection does not work after moving the wireless router or product	84
Cannot connect more computers to the wireless product	84
The wireless product loses communication when connected to a VPN	85
The network does not appear in the wireless networks list	85
The wireless network is not functioning	85
Product software issues (Windows)	85
Product software issues (OS X)	87
A print job was not sent to the product that you wanted	87
You are using a generic printer driver when using a USB connection	87

8 Service and support 88

Customer support	89
HP limited warranty statement	90
UK, Ireland, and Malta	91
Austria, Belgium, Germany, and Luxemburg	91
Belgium, France, and Luxemburg	92
Italy	93
Spain	93
Denmark	94
Norway	94
Sweden	94
Portugal	95
Greece and Cyprus	95
Hungary	95
Czech Republic	96
Slovakia	96
Poland	96
Bulgaria	97
Romania	97
Belgium and the Netherlands	97

Finland	98
Slovenia	98
Croatia	98
Latvia	98
Lithuania	99
Estonia	99
Russia	99

Appendix A Technical information 100

Product specifications	101
Print specifications	101
Physical specifications	101
Power consumption and electrical specifications	101
Acoustic emission specifications	101
Environmental specifications	101
Environmental product stewardship program	103
Protecting the environment	104
Ozone production	104
Power consumption	104
European Union Commission Regulation 1275/2008	104
Paper	104
HP PageWide printing supplies	104
Plastics	104
Electronic hardware recycling	105
Material restrictions	105
General battery information	105
Battery disposal in Taiwan	105
California Perchlorate Material Notice	105
EU Battery Directive	105
Battery notice for Brazil	106
Chemical substances	106
EPEAT	106
Disposal of waste equipment by users	106
Toxic and hazardous substance table (China)	107
Restriction on hazardous substances statement (Turkey)	107
Restriction on hazardous substances statement (Ukraine)	107
Restriction of hazardous substance statement (India)	107
China energy label for printer, fax, and copier	108
China SEPA Eco Label user information	108
Regulatory information	109
Regulatory notices	109

Regulatory model identification number	109
FCC statement	109
VCCI statement (Japan)	110
Power cord instructions	110
Power cord statement (Japan)	110
EMC statement (Korea)	110
Visual display workplaces statement for Germany	110
European Union Regulatory Notice	111
European Union Regulatory Notice	111
Wireless models only	111
Additional statements for wireless products	112
Exposure to radio frequency radiation	112
Notice to users in Brazil	112
Canadian statements	112
Japan statement	113
Notice to users in Korea	113
Taiwan statement	113
Mexico statement	113

Index	114
--------------------	------------

1 Product basics

- [Product features](#)
- [Product views](#)
- [Power on and off](#)
- [Use the control panel](#)
- [Quiet Mode](#)

Product features

<p>PageWide Pro 452dn</p> <p>D3Q15A, D3Q15B, D3Q15C, D3Q15D</p> 	<p>Tray capacity (75 GSM or 20-lb Bond paper)</p> <ul style="list-style-type: none"> Tray 1: 50 sheets Tray 2: 500 sheets Standard output bin: 300 sheets <p>Print</p> <ul style="list-style-type: none"> Simplex speeds up to 40 pages per minute (ppm) for both color and black with Professional quality Duplex speeds up to 21 ppm for both color and black with Professional quality Up to 55 ppm in General Office mode 	<p>Connectivity</p> <ul style="list-style-type: none"> 802.3 LAN (10/100) Ethernet port Host USB Type A and Type B ports (back)
<p>PageWide Pro 452dw</p> <p>D3Q16A, D3Q16B, D3Q16C, D3Q16D</p>	<p>Has the same features as the PageWide Pro 452dn, and includes the following:</p> <ul style="list-style-type: none"> Embedded wireless capability 802.11n 5GHz dual band support 	<ul style="list-style-type: none"> HP ePrint—send documents to the product email address for printing HP Wireless Direct support

Environmental features

Feature	Environmental benefit
Duplex printing	Automatic duplex printing is available on all models of HP PageWide Pro 452dn/dw series. Duplex printing saves the environment and saves you money.
Print multiple pages per sheet	Save paper by printing two or more pages of a document side-by-side on one sheet of paper. Access this feature through the printer driver.
Recycling	Reduce waste by using recycled paper. Recycle cartridges by using the HP Planet Partners return process.
Energy savings	Sleep modes and timer options enable this product to quickly go into reduced power states when not printing, thus saving energy.

Accessibility features

The product includes several features that aid users with limited vision, hearing, dexterity or strength.

- Online user guide that is compatible with text screen-readers.
- Cartridges can be installed and removed using one hand.
- All doors and covers can be opened using one hand.

Product views

- [Front view](#)
- [Back view](#)
- [Cartridge door view](#)

Front view

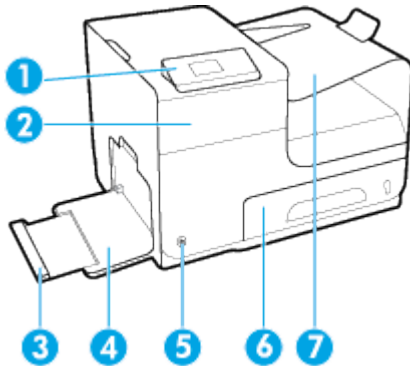

Label	Description
1	Control panel
2	Cartridge door
3	Tray 1 extension
4	Tray 1
5	Power button
6	Tray 2 – default paper tray
7	Output bin

Back view

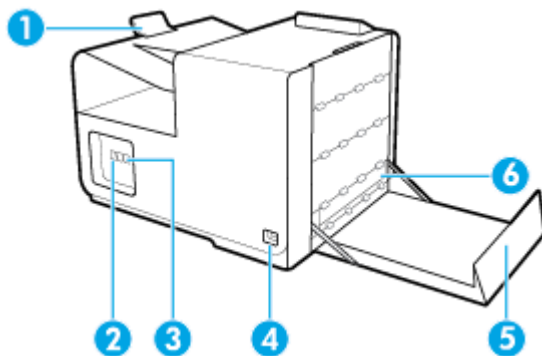

Label	Description
1	Output bin stop
2	Ethernet connection port

Label	Description
3	USB Type A and USB Type B ports
4	Power cord connection
5	Left door
6	Duplexer

Cartridge door view

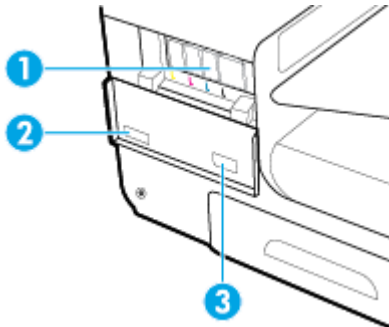

Label	Description
1	Cartridge slots
2	Product serial number and product number
3	Cartridge part numbers

Power on and off

NOTICE: To prevent damage to the product, use only the power cord that is provided with the product.

- [Turn the product on](#)
- [Manage power](#)
- [Turn the product off](#)

Turn the product on

1. Connect the power cord that is provided with the product to the connection port on the back of the product.
2. Connect the power cord to a wall outlet with an adequate voltage rating.



NOTE: Make sure that your power source is adequate for the product voltage rating. The product uses either 100–240 Vac or 200–240 Vac and 50/60 Hz.

3. Press and release the power button on the front of the product.

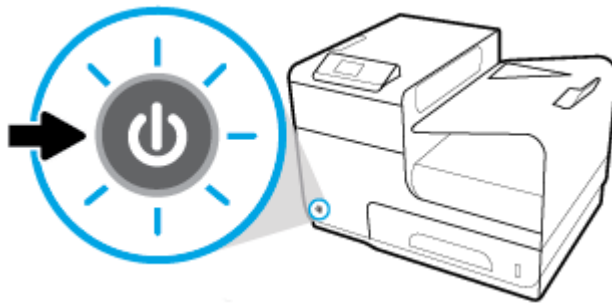

Manage power

HP PageWide Pro 452dn/dw series printers include power-management features that can help reduce power consumption and save energy.

- Sleep Mode puts the product in a reduced power-consumption state if it has been idle for a specific length of time. You can set the length of time before the product enters Sleep Mode from the control panel.
- Schedule On/Off enables you to turn the product on or off automatically at days and time that you set from the control panel. For example, you can set the product to turn off at 6 p.m. on Monday through Friday.

Set the Sleep Mode time

1. Open the control panel dashboard (swipe the dashboard tab at the top of any screen downward, or touch the dashboard area on the home screen).
2. On the control panel dashboard, touch .
3. Touch [Power Management](#), and then touch [Sleep Mode](#).
4. Select one of the time-interval options.

The product switches into a reduced power-consumption state when it has been idle for the amount of time that you select.

Schedule the product to turn on or off

1. On the printer control panel, touch **Setup** > **Printer Setup**.
2. Touch **Power Handling**, and then touch **Schedule Printer On/Off**.
3. Select the **Schedule On** or **Schedule Off** options, and then select the day and time that you want to schedule.

The product switches on or off at the time you select on the day you select.

Turn the product off

NOTICE: Do not turn off the product if a cartridge is missing. Damage to the product can result.

- ▲ Press and release the power button on the front of the product to turn off your HP PageWide Pro 452dn/dw series printer.

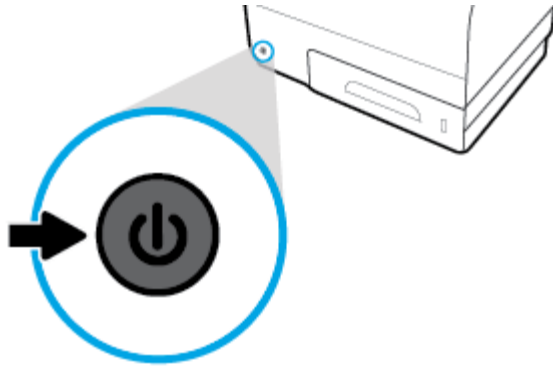

A warning message appears on the control panel if you attempt to turn the product off when one or more cartridges are missing.

NOTICE: To prevent print-quality problems, turn off the product by using the power button on the front only. Do not unplug the product, turn off the powerstrip, or use any other method.

Use the control panel





- [Control panel menu buttons](#)
- [Control panel menu navigation](#)
- [Control panel action buttons](#)
- [Control panel supply status](#)
- [Help features](#)

 **NOTE:** The small text on the control panel is not designed for prolonged viewing.

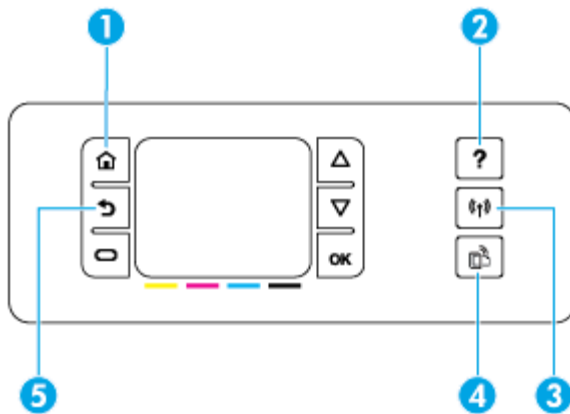
Control panel menu buttons

Buttons on the control panel of HP PageWide Pro 452dn/dw series printers enable you to view and navigate menus on the display screen.



1		Home button. Touch to view the control panel home screen.
2		Help button. Touch to view the Help menu options.
3		Wireless Solid blue when the product is connected to a wireless network. Blinks when the product is searching for a wireless connection. Off when the product is connected to a wired network, or by a USB cable. NOTE: Not available on the HP PageWide Pro 452dn model.
4		HP ePrint button. Press for access to HP Web Services features. Touch to access HP web services features. HP ePrint enables you to print from your computer, tablet, or smart phone by sending documents to the product's email address. NOTE: Not available on the HP PageWide Pro 452dn model.
5		Back button. Press to return to the previous menu or screen.

Control panel menu navigation

Buttons on the control panel enable you to scroll through menus and select from options that appear on a menu list.

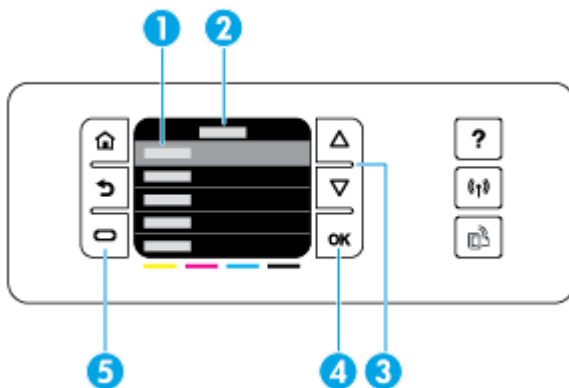

- 1 **Menu list.** Five menu items can appear on the display screen. Touch the **OK** button to choose the highlighted item.
- 2 **Menu title.** Appears at the top of the menu list.
- 3 **Up and down.** Use these buttons to scroll through the menu list and highlight an item.
- 4 **OK.** Touch to select the highlighted item from the menu list.
- 5 **Cancel.** Touch to cancel a print job or other current process, or to choose a menu item that appears at the lower left of the menu list.

Control panel action buttons

Sometimes the control panel displays a message asking you to cancel a process, like a print job, or to choose between two options: for example, **Cancel** or **Continue**. The options appear at the bottom of the menu list on the display screen.

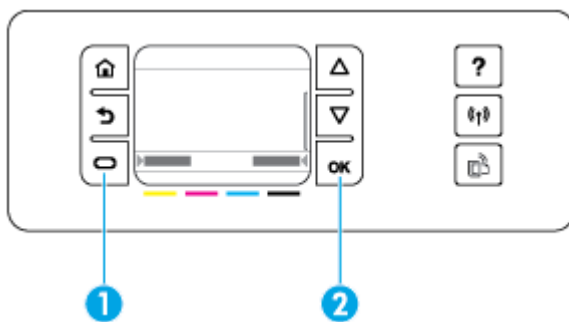

- 1 **Cancel.** Touch to cancel the current process, or to choose the option at the lower left of the menu list.
- 2 **OK.** Touch to choose the option that appears at the lower right of the menu list (for example, [Continue](#)).

Control panel supply status

You can check your HP PageWide cartridge levels from the printer control panel.

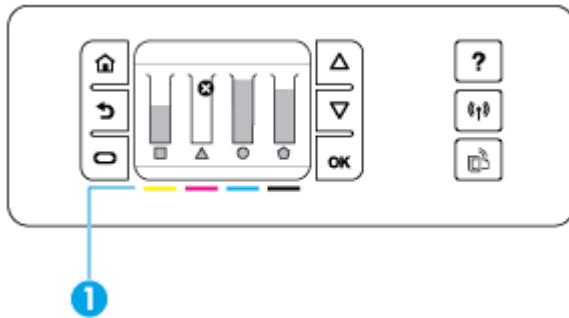

1. On the printer control panel, on the home screen, touch [Setup](#) .
2. Select [Tools](#).
3. Select [Supply Status](#).

The control panel displays the cartridge level for each of the four color cartridges.

1 **Cartridge levels.** The bars indicate the yellow, magenta, cyan, and black cartridge levels.

Help features

HP PageWide Pro 452dn/dw series printers have built-in help that is accessible from the control panel. Help features include tips, important product information that you can view or print, and animations that show how to perform tasks or solve problems.

To view these help features, touch **?** on the printer control panel.

- [Printer information](#)
- [Help animations](#)

Printer information

The Printer Status Report displays the following information about your HP PageWide Pro 452dn/dw series printer:

- Model name and number
- Product serial number
- Product Service ID
- Current firmware version number
- Usage, status, and settings information if you print the full product information and printer status report pages.

View or print a Printer Status report

1. On the printer control panel, on the home screen, touch [Setup](#) .
2. Touch [Print Reports](#).
3. Touch [Printer Status Report](#).

Help animations

The built-in help contains animations that show how to perform tasks or solve problems. To select and view an available help animation:

1. On the printer control panel, touch **?**.
2. Touch [How To Videos](#).
3. Select the animation that you want to play in the printer control panel display.

Quiet Mode

To minimize printer noise, use Quiet Mode. You can enable this mode from either the control panel or the HP Embedded Web Server (EWS).



NOTE: Quiet Mode slows the printer speed. If it hinders productivity, you can turn the mode off.

To turn Quiet Mode on or off from the control panel

1. Open the control panel dashboard (swipe the dashboard tab at the top of any screen downward, or touch the dashboard area on the home screen).
2. On the control panel dashboard, touch .
3. Touch [Quiet Mode](#) and turn it on or off.

To turn Quiet Mode on or off from the EWS

1. Open the EWS. For more information, see [Open the EWS](#).
2. Click the **Settings** tab.
3. In the **Preferences** section, click **Quiet Mode** and turn it on or off.
4. Click **Apply**.

2 Connect the product

- [Connect the product to a computer or a network](#)
- [Use Wi-Fi Direct to connect a computer or device to the product](#)
- [Install HP printer software for a wireless product already on the network](#)
- [Open the printer software \(Windows\)](#)
- [Manage network settings](#)

Connect the product to a computer or a network

To connect the product using a USB cable

You can use a USB cable to connect the product to a computer.

This product supports a USB 2.0 connection. Use an A-to-B type USB cable. HP recommends using a cable that is no longer than 2 m (6.5 ft).

NOTICE: Do not connect the USB cable until the installation software prompts you to connect it.

1. Quit all open programs on the computer.
2. Install the printer software from 123.hp.com/pagewide (recommended) or from the HP software CD provided with the printer, and follow the onscreen instructions.

 **NOTE:** If you are installing on a Mac, click **About HP Easy Start** to install the software.

3. When prompted, select the **USB-Connect the printer to the computer using a USB cable** option, and then click the **Next** button.

 **NOTE:** A dialog box displays a warning that Web Services (HP ePrint and print Apps) are unavailable with a USB installation. Click **Yes** to proceed with the USB installation, or click **No** to cancel it.

4. When the software prompts you, connect the Type B end of the USB cable to the connection port (1) at the rear of the product.

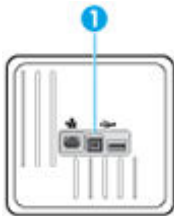

5. When the installation is complete, print a page from any program to make sure that the printing software is correctly installed.

To connect the product to a network

The product supports connection to either a wired or a wireless network.

Supported network protocols

HP PageWide Pro 452 products support the following network protocols.

• TCP/IPv4	• gSOAP
• IPv6	• SAND box
• DHCP, AutoIP	• LPD
• DHCP v6	• Bootp, Bootp TCE improvement
• HTTP server, HTTP client	• Netbios
• SMTP client for alerts	• WINS
• SNMP v1	• LLNMR
• Open_ssl library	• CIFS v6
• Bonjour	

Connect the product using a wired network

Use this procedure to install the product on a wired network using Windows.

1. Connect the Ethernet cable to the product (1) and to the network. Turn the product on.

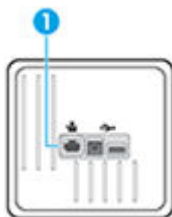

2. Wait for 60 seconds before continuing. During this time, the network recognizes the product and assigns an IP address or host name for the product.
3. Open the control panel dashboard (swipe the dashboard tab at the top of any screen downward, or touch the dashboard area on the home screen).
4. On the control panel dashboard, touch  to display the IP address. Touch [Print Details](#) to print a page with the IP address.

Connect the product using a wireless network (wireless models only)

You can connect the product to a wireless network using one of the following methods.

- [To connect the product to a wireless network using the Wireless Setup Wizard](#)
- [To connect the product to a wireless network using WPS](#)
- [To connect the product to a wireless network manually](#)

If your wireless router does not support Wi-Fi Protected Setup (WPS), obtain the wireless router network settings from your system administrator, or complete the following tasks.

- Obtain the wireless network name or service set identifier (SSID).
- Determine the security password or encryption key for the wireless network.

 **NOTE:** Before installing the product software, make sure the product is not connected to the network using an Ethernet cable.

To connect the product to a wireless network using the Wireless Setup Wizard

The Wireless Setup Wizard is the best method for installing the product on a wireless network.

1. Open the control panel dashboard (swipe the dashboard tab at the top of any screen downward, or touch the dashboard area on the home screen).
2. On the control panel dashboard, touch .
3. Touch **Network Setup**, and then touch **Wireless Settings**.
4. Touch **Wireless Setup Wizard**.
5. The product scans for available wireless networks and returns a list of network names (SSIDs). Select the SSID for your wireless router from the list if it is available. If the SSID for your wireless router is not in the list, touch **Enter SSID**. When prompted for the type of network security, select the option that your wireless router uses. A keypad opens on the control panel display.
6. Do one of the following:
 - If your wireless router uses WPA security, type the passphrase on the keypad.
 - If your wireless router uses WEP security, type the key on the keypad.
7. Touch **OK**, and wait while the product establishes a connection with the wireless router. Establishing the wireless connection can take a few minutes.

To connect the product to a wireless network using WPS

Before you can connect your printer to a wireless network using WPS, make sure you have the following:



- A wireless 802.11b/g/n network that includes a WPS-enabled wireless router or access point.

 **NOTE:** The printer supports only connections using 2.4GHz.



- A computer connected to the wireless network that you intend to connect the printer to. Be sure you have installed the HP printer software on the computer.

If you have a WPS router with a WPS push button, follow the **Push Button method**. If you are not certain your router has a push button, follow the **PIN method**.

Push Button method

1. On the control panel, press and hold  on the printer for more than three seconds to start WPS push mode. The  indicator starts blinking.
2. Press the WPS button on your router.
The product begins a timer for approximately two minutes while a wireless connection is established.

PIN method

1. Locate the WPS PIN.
 - a. Open the control panel dashboard (swipe the dashboard tab at the top of any screen downward, or touch the dashboard area on the home screen).
 - b. On the control panel dashboard, touch .
 - c. Touch [Network Setup](#), and then touch [Wireless Settings](#).
 - d. Touch [Wi-Fi Protected Setup](#), and then touch [PIN](#).
2. On the control panel, press and hold  on the printer for more than three seconds to start WPS push mode. The  indicator starts blinking.
3. Open the configuration utility or software for the wireless router or wireless access point, and then enter the WPS PIN.



NOTE: For more information about using the configuration utility, see the documentation provided with the router or wireless access point.

4. Wait for about two minutes. If the printer connects successfully, the  indicator stops blinking but remains lit.

To connect the product to a wireless network manually

During the first 120 minutes of product setup, or after resetting the product's network defaults (and without a network cable attached to the product), the product's wireless radio will broadcast a wireless setup network for the product.

The name of this network is "HP-Setup-xx-[product name]".



NOTE: The "xx" in the network name is the last two characters of the product's MAC address. The product name is HP PageWide Pro 452.

1. From a wireless enabled product, connect to the setup network for the device.
2. Open a web browser while connected to this setup network, and open the HP Embedded Web Server (EWS) using the following IP address.
 - 192.168.223.1
3. Find the Wireless Setup Wizard in the EWS and follow the instructions to manually connect the product.



NOTE: The product uses Automatic DHCP by default.

Use Wi-Fi Direct to connect a computer or device to the product



With Wi-Fi Direct, you can print wirelessly from a computer, smart phone, tablet, or other wireless-capable device—without connecting to an existing wireless network.

Guidelines for using Wi-Fi Direct

- Make sure your computer or mobile device has the necessary software.
 - If you are using a computer, make sure you have installed the printer software from 123.hp.com/pagewide (recommended) or from the HP software CD provided with the printer.

If you have not installed the HP printer software on the computer, connect to Wi-Fi Direct first and then install the printer software. Select **Wireless** when prompted by the printer software for a connection type.
 - If you are using a mobile device, make sure you have installed a compatible printing app. For more information about mobile printing, visit the HP Mobile Printing website.
- Make sure Wi-Fi Direct for your printer is turned on.
- Up to five computers and mobile devices can use the same Wi-Fi Direct connection.
- Wi-Fi Direct can be used while the printer is also connected either to a computer using a USB cable or to a network using a wireless connection.
- Wi-Fi Direct cannot be used to connect a computer, mobile device, or printer to the Internet.

To turn on Wi-Fi Direct

1. Open the control panel dashboard (swipe the dashboard tab at the top of any screen downward, or touch the dashboard area on the home screen).
2. On the control panel dashboard, touch .
3. Touch .
4. If the display shows that Wi-Fi Direct is off, touch [Wi-Fi Direct](#) and switch it on.

 **TIP:** You can also turn on Wi-Fi Direct from the EWS. For more information about using the EWS, see [HP Embedded Web Server](#).

To print from a wireless-capable mobile device

Make sure you have installed a compatible printing app on your mobile device. For more information, visit the [HP Mobile Printing](#) website.

1. Make sure you have turned on Wi-Fi Direct on the printer.
2. Turn on the Wi-Fi connection on your mobile device. For more information, see the documentation provided with the mobile device.

 **NOTE:** If your mobile device does not support Wi-Fi, you are not able to use Wi-Fi Direct.

3. From the mobile device, connect to a new network. Use the process you normally use to connect to a new wireless network or hotspot. Choose the Wi-Fi Direct name from the list of wireless networks

shown such as **DIRECT-**-HP PageWide XXXX** (where ** are the unique characters to identify your printer and XXXX is the printer model located on the printer).

Enter the Wi-Fi Direct password when prompted.

4. Print your document.

To print from a wireless-capable computer (Windows)

1. Make sure Wi-Fi Direct for your printer is turned on.
2. Turn on the computer's Wi-Fi connection. For more information, see the documentation provided with the computer.



NOTE: If your computer does not support Wi-Fi, you are not able to use Wi-Fi Direct.

3. From the computer, connect to a new network. Use the process you normally use to connect to a new wireless network or hotspot. Choose the Wi-Fi Direct name from the list of wireless networks shown such as **DIRECT-**-HP PageWide XXXX** (where ** are the unique characters to identify your printer and XXXX is the printer model located on the printer).

Enter the Wi-Fi Direct password when prompted.



NOTE: To find the password, touch  (Wi-Fi Direct) on the home screen.

4. Proceed to step 5 if the printer has been installed and connected to the computer over a wireless network. If the printer has been installed and connected to your computer with a USB cable, follow the steps below to install the printer software using the HP Wi-Fi Direct connection.
 - a. Open the printer software. For more information, see [Open the printer software \(Windows\)](#).
 - b. Click **Printer Setup & Software**, and then select **Connect a new printer**.
 - c. When the **Connection Options** software screen appears, select **Wireless**.
Select your HP printer software from the list of detected printers.
 - d. Follow the onscreen instructions.
5. Print your document.

To print from a wireless-capable computer (OS X)

1. Make sure Wi-Fi Direct for your printer is turned on.
2. Turn on Wi-Fi on the computer.
For more information, see the documentation provided by Apple.
3. Click the Wi-Fi icon and choose the Wi-Fi Direct name, such as **DIRECT-**-HP PageWide XXXX** (where ** are the unique characters to identify your printer and XXXX is the printer model located on the printer).
If Wi-Fi Direct is turned on with security, enter the password when prompted.
4. Add the printer.
 - a. Open **System Preferences**.
 - b. Click **Printers**.

- c. Click + below the list of printers at the left.
- d. Select the printer from the list of detected printers (the word “Bonjour” is listed in the right column beside the printer name), and click **Add**.

Install HP printer software for a wireless product already on the network

If the product already has an IP address on a wireless network and you want to install product software on a computer, complete the following steps.

1. Obtain the product IP (on the control panel dashboard, touch .
2. Install the printer software from 123.hp.com/pagewide (recommended) or from the HP software CD provided with the printer.
3. Follow the onscreen instructions.
4. When prompted, select **Wireless - Connect the printer to your wireless network and internet**, and then click **Next**.
5. From the list of available printers, select the printer that has the correct IP address.

Open the printer software (Windows)

Depending on your operating system, you can open the printer software as follows:

- **Windows 10:** From the computer desktop, click **Start**, select **All apps**, click **HP**, click the folder for the printer, and then select the icon with the printer's name.
- **Windows 8.1:** Click the down arrow in lower left corner of the Start screen, and then select the printer name.
- **Windows 8:** Right-click an empty area on the Start screen, click **All Apps** on the app bar, and then select the printer name.
- **Windows 7, Windows Vista, and Windows XP:** From the computer desktop, click **Start**, select **All Programs**, click **HP**, click the folder for the printer, and then select the icon with the printer's name.

Manage network settings

- [View or change network settings](#)
- [Set or change the product password](#)
- [Manually configure TCP/IP parameters from the control panel](#)
- [Link speed and duplex settings](#)

View or change network settings

Use the HP Embedded Web Server to view or change IP configuration settings.

1. Obtain the product IP (on the control panel dashboard, touch .
2. Type the product IP address into the address bar of a web browser to open the HP Embedded Web Server.
3. Click the **Network** tab to obtain network information. You can change settings as needed.

Set or change the product password

Use the HP Embedded Web Server to set a password or change an existing password for a product on a network so unauthorized users cannot change the product settings.

1. Obtain the product IP (on the control panel dashboard, touch .
2. Type the product IP address into the address bar of a web browser. Click the **Settings** tab, click **Security**, and then click the **Password Settings** link.



NOTE: If a password has previously been set, you are prompted to type the password. Type “admin” for User Name along with the password, and then click **Apply**.

3. Type the new password in the **Password** field and in the **Confirm Password** field.
4. At the bottom of the window, click **Apply** to save the password.

Manually configure TCP/IP parameters from the control panel

Use the control panel menus to manually set an IPv4 address, subnet mask, and default gateway.

1. Open the control panel dashboard (swipe the dashboard tab at the top of any screen downward, or touch the dashboard area on the home screen).
2. On the control panel dashboard, touch .
3. Touch **Network Setup**, and then touch **Ethernet Settings**.
4. Touch **Advanced Settings**, and then touch **IP Settings**.
5. Touch **Manual**, and then touch **IP Address**.
6. Using the numeric keypad, do the following:
 - Enter the IP address, and touch **Done** .
 - Enter the subnet mask, and touch **Done** .
 - Enter the default gateway, and touch **Done** .
7. Touch **Apply**.

Link speed and duplex settings



NOTE: This information applies only to Ethernet (wired) networks. It does not apply to wireless networks.

The link speed and communication mode of the print server must match the network hub. For most situations, leave the product in automatic mode. Incorrect changes to the link speed and duplex settings might prevent the product from communicating with other network devices. If you need to make changes, use the printer control panel.

**NOTE:**

- The setting must match with the network product to which you are connecting (a network hub, switch, gateway, router, or computer).
 - Making changes to these settings causes the product to turn off and then on. Make changes only when the product is idle.
1. Open the control panel dashboard (swipe the dashboard tab at the top of any screen downward, or touch the dashboard area on the home screen).
 2. On the control panel dashboard, touch .
 3. Touch [Network Setup](#), and then touch [Ethernet Settings](#).
 4. Touch [Advanced Settings](#), and touch [Link Speed](#).
 5. Select one of the following options.

Setting	Description
Automatic	The print server automatically configures itself for the highest link speed and communication mode allowed on the network.
10-Full	10 Mbps, full-duplex operation
10-Half	10 Mbps, half-duplex operation
100-Full	100 Mbps, full-duplex operation
100-Half	100 Mbps, half-duplex operation

3 Printer management and services

- [HP Embedded Web Server](#)
- [Web Services](#)
- [HP Web Jetadmin software](#)
- [Product security features](#)
- [HP Printer Assistant in the printer software \(Windows\)](#)
- [HP Utility \(OS X\)](#)
- [AirPrint™ \(OS X\)](#)

HP Embedded Web Server

- [About the EWS](#)
- [About cookies](#)
- [Open the EWS](#)
- [Features](#)

About the EWS

This product is equipped with the HP Embedded Web Server (EWS), which provides access to information about product and network activities. EWS provides an environment in which Web programs may run, much in the same way that an operating system, such as Windows, provides an environment for programs to run on a computer. The output from these programs can then be displayed by a web browser.

The EWS resides on a hardware device (such as an HP printer) or in firmware, rather than as software that is loaded on a network server.

The advantage of the EWS is that it provides an interface to the product that anyone with a network-connected product and computer can use. There is no special software to install or configure, but you must have a supported web browser on the computer. To gain access to the EWS, type the IP address for the product in the address bar of the browser.

About cookies

The EWS places very small text files (cookies) on your hard drive when you are browsing. These files let the EWS recognize your computer the next time you visit. For example, if you have configured the EWS language, a cookie helps remember which language you have selected so that the next time you access the EWS, the pages are displayed in that language. Though some cookies are cleared at the end of each session (such as the cookie that stores the selected language), others (such as the cookie that stores customer-specific preferences) are stored on the computer until you clear them manually.

 **IMPORTANT:** The cookies that the EWS stores on your computer are used only for saving settings on your computer or for sharing information between the printer and the computer. These cookies are not sent to any HP websites.

You can configure your browser to accept all cookies, or you can configure it to alert you every time a cookie is offered, which allows you to decide which cookies to accept or refuse. You can also use your browser to remove unwanted cookies.

Depending on your printer, if you disable cookies, you also disable one or more of the following features:

- Starting where you left the application (especially useful when using setup wizards).
- Remembering the EWS browser language setting.
- Personalizing the EWS home page.

For information about how to change your privacy and cookie settings and how to view or delete cookies, see the documentation available with your web browser.

Open the EWS

To open the EWS, do one of the following:

- In a supported web browser, type the product IP address into the address box. (To obtain the IP address, on the control panel dashboard, touch )
- In the printer software, open the HP Printer Assistant and on the **Print** tab, click **Printer Home Page (EWS)**.

For more information, see [Open the HP Printer Assistant](#).

- In OS X, use HP Utility or click **System Preferences > Printers > HP PageWide Pro 452 > Options & Supplies > General > Show Printer Webpage**.

 **NOTE:** If an error occurs while opening the EWS, confirm that the proxy settings are correct for your network.

 **TIP:** After you open the URL, bookmark it so that you can return to it quickly in the future.

Features

- [Home tab](#)
- [Web Services tab](#)
- [Network tab](#)
- [Tools tab](#)
- [Settings tab](#)

 **NOTE:** Changing network settings in the EWS might disable some product or product software features.

Home tab

Use the **Home** tab to access frequently used items from the **Web Services**, **Network**, **Tools**, and **Settings** tabs. The **Home** tab includes the following items.

 **NOTE:** Not all of the following items are visible by default. Use the **Personalize** button to show or hide the items of your choice.

Item	Description
Energy Save Settings	Configure energy-saving features that switch the printer to Sleep Mode or turn the printer on or off automatically
Web Services	Enable or disable HP ePrint or print apps that allow you to print from email
Printer Update	Check for new printer updates
Estimated Cartridge Levels	Review cartridge level status
Network Summary	View wired (802.3) status or wireless (802.11) status
Print Quality Toolbox	Run maintenance tools to improve print quality
Wireless Setup Wizard	Set up a wireless connection using the wizard

Item	Description
Wi-Fi Direct	Set up Wi-Fi Direct to print from a mobile device directly to the printer without connecting to a wireless network
AirPrint	Set up AirPrint™ for printing from Apple-supported products
Printer Information	View information about the printer, such as product serial number, service ID, firmware version, and total page count
Administrator	Set up administrator control of printer features
Backup	Back up the printer settings into a password-encrypted file
Firewall	Configure the network firewall
Printer Reports	Print the information pages about your printer
Usage Report	Display usage counters for print jobs

 **NOTE:** Settings for this page are automatically saved in the web browser's cookies. If the web browser's cookies are deleted, these settings are lost.

Web Services tab

Use the **Web Services** tab to configure and enable HP Web Services for this product. You must enable HP Web Services to use the HP ePrint feature.

Network tab

Use the **Network** tab to configure and secure network settings for the product when it is connected to an IP-based network. The **Network** tab does not appear if the product is connected to other types of networks.

Tools tab

Use the **Tools** tab to view or manage product utilities. The **Tools** tab includes the following items.

Item	Description
Product Information	<ul style="list-style-type: none"> • Printer Information: View information about the printer, such as product serial number, service ID, firmware version, and total page count • Cartridge Level Gauge: Review cartridge level status • Cartridge Settings: Set the threshold at which the printer provides notifications that cartridges are running low
Reports	<ul style="list-style-type: none"> • Usage Report: View the number of pages processed for printing • Printer Reports: Print various reports, such as font lists • Event Log: View the printer's last 50 error messages • Job Log: View a list of the most recent jobs performed by the printer • Color Usage Job Log: View the number of pages printed in black-and-white/grayscale and color for all jobs and for individual jobs

Item	Description
Utilities	<ul style="list-style-type: none"> • Bookmarking: Bookmark pages in the EWS • Print Quality Toolbox: Run maintenance tools to improve the print quality of your printouts • Asset Tracking: Assign an asset number/location to this device
Backup and Restore	<ul style="list-style-type: none"> • Backup: Create a password-encrypted file that stores the printer's settings • Restore: Restore the printer's settings using a backup file created by the EWS
Printer Restart	Power Cycle: Turn off and restart the printer
Printer Updates	Firmware Updates: Set up the printer to alert you of updates or to automatically install updates

Settings tab

Use the **Settings** tab to set and maintain various options on your product including power management, date and time, printing and paper settings, email alerts, factory defaults, and firewall settings.

Item	Description
Power Management	Set up the Energy Save mode to minimize the amount of power that the product consumes when idle and to reduce wear on electronic components
Preferences	Configure the default settings for general printer features such as date and time, language, display, and anonymous usage information. You can also set the default values for specific features such as manual feed, tray and paper management, image registration, ColorLok, and Quiet Mode.
Security	Configure settings to prevent unauthorized use of the printer or specific printer features. For more information, see Security settings .
Email Alerts	Set the default values for the email server, alert destinations, and alert settings
Print Settings	Configure default settings for printing (such as font, print quality, duplexing, and black-and-white or color printing)
Restore Defaults	Restore the factory defaults or the network settings
Firewall	Configure firewall settings such as rules, addresses, services, and other options

Web Services

- [What are Web Services?](#)
- [Set Up Web Services](#)
- [Use Web Services](#)
- [Remove Web Services](#)

What are Web Services?

The printer offers innovative, web-enabled solutions that can help you quickly access the Internet, obtain documents, and print them faster and with less hassle—and all without using a computer.



NOTE: To use these web features, the printer must be connected to the Internet (either using an Ethernet cable or wireless connection). You cannot use these web features if the printer is connected using a USB cable.

HP ePrint

HP ePrint is a free service from HP that allows you to print to your HP ePrint-enabled printer anytime, from any location. It's as simple as sending an email to the email address assigned to your printer when you enable Web Services on the printer. No special drivers or software are needed. If you can send an email, you can print from anywhere, using HP ePrint.



NOTE:

- You can sign up for an account at the [HP Connected](#) website (might not be available in all countries/regions), and sign in to configure the ePrint settings.
 - After you sign up for an account at the HP Connected website, you can sign in to view your HP ePrint job status, manage your HP ePrint printer queue, control who can use your printer's HP ePrint email address to print, and get help for HP ePrint.
-

Print apps

- Print apps allow you to easily locate and print preformatted web content, directly from your printer. You can also store your documents digitally on the web.
- Preformatted content designed specifically for your printer means no cut-off text and pictures and no extra pages with only one line of text. On some printers, you can also choose paper and print quality settings on the print preview screen.

Set Up Web Services

Before you set up Web Services, make sure your printer is connected to the Internet using either an Ethernet or wireless connection.

To set up Web Services, use one of the following methods.

To set up Web Services using the control panel

1. Open the control panel dashboard (swipe the dashboard tab at the top of any screen downward, or touch the dashboard area on the home screen).
2. On the control panel dashboard, touch .
3. Touch [Web Services Setup](#).
4. Touch [Accept](#) to accept the Web Services terms of use and enable Web Services.
5. On the screen that appears, touch [OK](#) to allow the printer to automatically check for product updates.



NOTE: If prompted for proxy settings and if your network uses proxy settings, follow the onscreen instructions to set up a proxy server. If you do not have the proxy details, contact your network administrator or the person who set up the network.

6. If the [Printer Update Options](#) screen appears, touch [Install Automatically \(Recommended\)](#) or [Alert When Available](#).
7. When the printer is connected to the server, the printer prints an information page. Follow the instructions on the information page to finish the setup.

To set up Web Services using the EWS

1. Open the EWS. For more information, see [Open the EWS](#).
2. Click the **Web Services** tab.
3. In the **Web Services Settings** section, click **Setup**, click **Continue**, and follow the onscreen instructions to accept the terms of use.
4. If prompted, choose to allow the printer to check for and install printer updates.



NOTE: If prompted for proxy settings and if your network uses proxy settings, follow the onscreen instructions to set up a proxy server. If you do not have the proxy details, contact your network administrator or the person who set up the network.

5. When the printer is connected to the server, the printer prints an information page. Follow the instructions on the information page to finish the setup.

Use Web Services

- [HP ePrint](#)
- [Print apps](#)

HP ePrint

To use HP ePrint, do the following:

- Be sure you have an Internet- and email-capable computer or mobile device.
- Enable Web Services on the printer. For more information, see [Set Up Web Services](#).

For more information about managing and configuring HP ePrint settings and to learn about the latest features, visit [HP Connected](#). This site might not be available in all countries/regions.

To print documents using HP ePrint

1. On your computer or mobile device, open your email application.
2. Create a new email message, and then attach the file that you want to print.
3. Enter the HP ePrint email address in the “To” field, and then select the option to send the email message.





NOTE: Do not enter any additional email addresses in either the "To" or "Cc" fields. The HP ePrint server does not accept print jobs if there are multiple email addresses.

To find the HP ePrint email address

1. Open the control panel dashboard (swipe the dashboard tab at the top of any screen downward, or touch the dashboard area on the home screen).
2. On the control panel dashboard, touch .
3. Touch [Web Services Setup](#), and then touch [Print Info Page](#). The printer prints an information page that contains the printer code and instructions on how to customize the email address.

To turn off HP ePrint from the control panel

1. Open the control panel dashboard (swipe the dashboard tab at the top of any screen downward, or touch the dashboard area on the home screen).
2. On the control panel dashboard, touch .
3. Touch , and then touch [HP ePrint](#) and turn it off.

To turn off HP ePrint in the EWS

1. Open the EWS. For more information, see [Open the EWS](#).
2. Click the **Web Services** tab.
3. In the **Web Services Settings** section, for **HP ePrint**, click **Turn Off**.
4. In the confirmation dialog box that appears, click **Yes**.

Print apps

Print apps allow you to easily locate and print preformatted web content, directly from your printer.

To use print apps

1. On the control panel, touch the [Apps](#) application folder.
2. Touch the print app you want to use.

For more information about an individual print app, visit the [HP Connected](#) website. This site might not be available in all countries/regions.

To manage print apps

You can add, configure, or remove print apps, and set the order in which they appear on your printer control panel display.

1. On the control panel, touch the [Apps](#) application folder.
2. In the display, touch the [Manage](#) icon and follow the onscreen instructions.





NOTE: You can also manage your print apps at the [HP Connected](#) website.

Remove Web Services

Use the following instructions to remove Web Services.

To remove Web Services using the control panel

1. Open the control panel dashboard (swipe the dashboard tab at the top of any screen downward, or touch the dashboard area on the home screen).
2. On the control panel dashboard, touch .
3. Touch , and then touch [Remove Web Services](#) and touch **Yes**.

To remove Web Services using the EWS

1. Open the EWS. For more information, see [Open the EWS](#).
2. Click the **Web Services** tab.
3. In the **Web Services Settings** section, click **Remove Web Services**.
4. Click **Remove Web Services** to confirm.
5. Click **Yes** to remove Web Services from your printer.

HP Web Jetadmin software

HP Web Jetadmin is an award-winning, industry-leading tool for efficiently managing a wide variety of networked HP devices, including printers, multifunction products, and digital senders. This single solution allows you to remotely install, monitor, maintain, troubleshoot, and secure your printing and imaging environment — ultimately increasing business productivity by helping you save time, control costs, and protect your investment.

HP Web Jetadmin updates are periodically made available to provide support for specific product features. Visit the [HP Web Jetadmin](#) website, and click **Download now**.

Product security features

- [Security statements](#)
- [Firewall](#)
- [Security settings](#)
- [Firmware updates](#)

Security statements

This product supports security standards and protocols that help secure the product, protect information on your network, and simplify monitoring and maintenance of the product.

For information about HP's secure imaging and printing solutions, visit the [HP secure printing](#) website. The site provides links to white papers and FAQ documents about security features and may include information about additional security features that are not contained in this document.

Firewall

The HP Embedded Web Server allows you to enable and configure product firewall rules, priorities, templates, services, and policies. The firewall feature provides a network layer of security on both IPv4 and IPv6 networks. The firewall configuration capability gives you control over IP addresses that are allowed to access

the product. It also lets you set permissions and priorities for digital send, management, discovery, and print services. All of this helps provide a more secure way of controlling access to the product.

The firewall feature also allows you to disable unused protocols and services. These protocol and services settings can also be protected from being changed by setting the EWS admin password. These protocols and services include the following.

Protocol or service	Description
IPv4 and IPv6	To operate properly on a TCP/IP network, the product must be configured with valid TCP/IP network configuration settings, such as an IP address that is valid for your network. This product supports two versions of this protocol: version 4 (IPv4) and version 6 (IPv6). IPv4 and IPv6 can be enabled/disabled individually or simultaneously enabled.
Bonjour	Bonjour services are typically used on small networks for IP address and name resolution where a conventional DNS server is not used. The Bonjour service can be enabled or disabled.
SNMP	SNMP (Simple Network Management Protocol) is used by network management applications for product management. This product supports the SNMPv1 protocol on IP networks. This product allows the ability to enable/disable SNMPv1.
WINS	If you have a Dynamic Host Configuration Protocol (DHCP) service on your network, the product automatically obtains its IP address from that server and registers its name with any RFC 1001 and 1002-compliant dynamic name services as long as the Windows Internet Name Service (WINS) server IP address has been specified. The WINS server IP address configuration can be enable or disabled. If enabled, then the primary and secondary WINS server can be specified.
SLP	Service Location Protocol (SLP) is an Internet standard network protocol that provides a framework to allow network applications to discover the existence, location and configuration of networked services in enterprise networks. This protocol can be enabled or disabled.
LPD	Line Printer Daemon (LPD) refers to the protocol and programs associated with line-printer spooling services that may be installed on various TCP/IP systems. LPD can be enabled or disabled.
LLMNR	Link-Local Multicast Name Resolution (LLMNR) is a protocol based on the Domain Name System (DNS) packet format that allows both IPv4 and IPv6 hosts to perform name resolution for hosts on the same local link. LLMNR can be enabled or disabled.
Port 9100	The product supports raw IP printing through TCP Port 9100. This HP-propriety TCP/IP port on the product is the default port for printing and it is accessed by HP software. Port 9100 can be enabled or disabled.
Web Services	The product supports the ability to enable or disable Microsoft Web Services Dynamic Discovery (WS Discovery) protocols or Microsoft Web Services for Devices (WSD) Print services supported on the product. These web services can be enabled or disabled together or WS Discovery can be enabled separately.
Internet Printing Protocol (IPP)	Internet Printing Protocol (IPP) is an Internet-standard protocol that allows you to print documents and manage jobs over the internet. IPP can be disabled or enabled.

Security settings

On the **Settings** tab of the Embedded Web Server, under **Security**, you can find the following options.

Item	Description
Password Settings	Set a password to prevent unauthorized users from remotely configuring the printer or viewing printer settings from the EWS

Item	Description
Administrator Settings	Customize your printer by enabling or disabling features related to network connectivity, Web Services, printer functions (such as color printing), memory devices, and firmware updates
Control Panel Shortcuts	Select which shortcuts appear in the Shortcuts folder on the printer control panel
Access Control	Enable and configure sign-in methods to control user access to specific printer tasks
Protect Stored Data	Configure settings to protect jobs stored on the printer from unauthorized users

For more information about security settings, see the [EWS administrator guide](#) (English only).

Firmware updates

The printer firmware can be automatically updated. On the **Tools** tab of the Embedded Web Server, click **Printer Updates**, **Firmware Updates**, and then **Install updates automatically**. HP recommends using this option.

HP Printer Assistant in the printer software (Windows)

The HP Printer Assistant provides access to HP printer features and resources from the Windows programs menu or the desktop icon on your computer.

Open the HP Printer Assistant

1. On your computer, click **Start**, and then click **All Programs**.
2. Click **HP**, click the name of the product, and then click your printer.

Features

- [Connected tab](#)
- [Print tab](#)
- [Shop tab](#)
- [Help tab](#)
- [Tools tab](#)
- [Estimated Levels tab](#)

Connected tab

Click the **Connected** tab to access the [HP Connected](#) website (might not be available in all countries/regions). HP Connected gives you a single login for select HP apps and cloud solutions plus access to the HP Connected platform from a smartphone, tablet, computer, or web-enabled HP printer. You can sign into HP Connected using your existing ePrintCenter account or sign up for a new HP Connected account.

Print tab

Use the **Print** tab to view or manage print utilities. This tab includes the following items.

Item	Description
Print	<ul style="list-style-type: none"> • Connect Printer to the Web: Click to open the HP website and get new content and solutions for your HP web-connected printer • Set Preferences: Click to open your Printing Preferences dialog box to view and change defaults for paper size, print quality, and more • Maintain Your Printer: Click to open the Toolbox to align and clean cartridges or print a diagnostic page • Print From Your Mobile Devices: Click to open the HP Mobile Printing website to learn how to print from your smartphone or tablet. If a local version of this website is not available in your country/region, you might be directed to the HP Mobile Printing site in another country/region or language. • See What's Printing: Click to open the print monitor and view, pause, or cancel your print jobs • Customize Your Printer: Click to open your Printing Preferences dialog box to change the name, security settings, or other properties of your printer • Printer Home Page (EWS): Click to open the HP Embedded Web Server to configure, monitor, and maintain your printer

Shop tab

Use the **Shop** tab to shop for HP supplies and other products online.

Help tab

Use the **Help** tab to access resources such as online help and HP Eco Solutions.

Tools tab

Use the **Tools** tab to set and maintain the printer driver and software and to diagnose and resolve printing and connectivity problems.

Estimated Levels tab

Use the **Estimated Levels** tab to review cartridge levels and to order new cartridges, if needed.

HP Utility (OS X)

HP Utility contains tools to configure print settings, calibrate the printer, order supplies online, and find website support information.



NOTE: The features available in HP Utility vary depending on the selected printer.

Cartridge level warnings and indicators provide estimates for planning purposes only. When you receive a low-cartridge warning message, consider having a replacement cartridge available to avoid possible printing delays. You do not need to replace cartridges until the print quality becomes unacceptable.

Open HP Utility

- ▲ Double-click **HP Utility** in the **HP** folder, in the **Applications** folder.

AirPrint™ (OS X)

Your product supports printing with Apple's AirPrint for iOS 4.2 and Mac OS X v10.9 or later. Use AirPrint to print wirelessly to the printer from an iPad (iOS 4.2), iPhone (3GS or later), or iPod touch (third generation or later).

For more information, see [Print with AirPrint \(OS X\)](#).

4 Paper and print media

- [Understand paper use](#)
- [Supported media sizes](#)
- [Supported paper types and tray capacity](#)
- [Configure trays](#)
- [Load media](#)
- [Tips for selecting and using paper](#)

Understand paper use

HP PageWide cartridges for business are specifically developed for use with HP printheads. Unique formulations help extend the life of the printheads and enhance reliability. When used with ColorLok® paper, these cartridges provide laser-like color output that dries quickly and is ready for distribution.

 **NOTE:** Based on HP internal testing using a range of plain papers, HP highly recommends using papers with the ColorLok® logo for this product. For details, visit the [HP print permanence](#) website.



This product supports a variety of paper and other print media. Paper or print media that does not meet the following guidelines might cause poor print quality, increased jams, and premature wear on the product.

It is possible for paper to meet all of these guidelines and still not produce satisfactory results. This might be the result of improper handling, unacceptable temperature and/or humidity levels, or other variables over which HP has no control.

NOTICE: Using paper or print media that does not meet HP specifications might cause problems for the product, requiring repair. This repair is not covered by the HP warranty or service agreements.

Use the following guidelines to obtain satisfactory results when using special paper or print media. Set the paper type and size in the printer driver to obtain the best results.

Media type	Do	Do not
Envelopes	<ul style="list-style-type: none">• Store envelopes flat.• Use envelopes where the seam extends all the way to the corner of the envelope.	<ul style="list-style-type: none">• Do not use envelopes that are wrinkled, nicked, stuck together, or otherwise damaged.• Do not use envelopes that have clasps, snaps, windows, or coated linings.
Labels	<ul style="list-style-type: none">• Use fresh labels. Old labels are more likely to delaminate during printing.• Use only labels that have no exposed backing between them.• Use labels that lie flat.• Use only full sheets of labels.	<ul style="list-style-type: none">• Do not use labels that have wrinkles or bubbles, or are damaged.• Do not print partial sheets of labels.
Letterhead or preprinted forms	<ul style="list-style-type: none">• Use only letterhead or forms approved for use in HP PageWide products.	<ul style="list-style-type: none">• Do not use raised or metallic letterhead.
Heavy paper	<ul style="list-style-type: none">• Use only heavy paper that is approved for use in HP PageWide products and meets the weight specifications for this product.	<ul style="list-style-type: none">• Do not use paper that is heavier than the recommended media specification for this product unless it is HP paper that has been approved for use in this product.
Glossy or coated paper	<ul style="list-style-type: none">• Use only glossy or coated paper that is approved for use in HP PageWide products.	<ul style="list-style-type: none">• Do not use glossy or coated paper designed for use in laser products.

NOTICE: Do not use any media that contains staples or paper clips.

Supported media sizes

For best results, use the appropriate paper and media sizes:

- [Supported paper and print media sizes](#)
- [Supported envelope sizes](#)
- [Supported card and label sizes](#)
- [Supported photo media sizes](#)

Supported paper and print media sizes

Size	Dimensions	Tray 1	Tray 2	Electronic duplex printing
Letter	216 x 279 mm (8.5 x 11 inches)	✓	✓	✓
Oficio 8.5 x 13	(8.5 x 13 inches)	✓		✓
Oficio 216x340 mm	216 x 340 mm	✓		✓
Legal	216 x 356 mm (8.5 x 14 inches)	✓		✓
A4	210 x 297 mm (8.3 x 11.7 inches)	✓	✓	✓
Executive	184 x 267 mm (7.25 x 10.5 inches)	✓	✓	✓
Statement	140 by 216 mm (5.5 x 8.5 inches)	✓	✓	
A5	148 x 210 mm (5.8 x 8.3 inches)	✓	✓	
A6	105 x 148.5 mm (4.13 x 5.83 inches)	✓		
B5 (JIS)	182 x 257 mm (7.17 x 10.12 inches)	✓	✓	✓
B6 (JIS)	128x182 mm (5 x 7 inches)	✓		
16k	184 x 260 mm (7.24 x 10.23 inches)	✓	✓	
	195 x 270 mm (7.68 x 10.62 inches)	✓	✓	
	197 x 273 mm (7.75 x 10.75 inches)	✓	✓	
Custom	Minimum: 76 x 127 mm (3 x 5 inches) Maximum: 216 x 356 mm (8.5 x 14 inches)	Width: 76 to 216 mm (3 to 8.5 inches) Length: 127 to 356 mm (5 to 14 inches)	Width: 102 to 216 mm (4 to 8.5 inches) Length: 210.06 to 297.2 mm (8.27 to 11.7 inches)	

Supported envelope sizes

Size	Dimensions	Tray 1	Tray 2
Envelope #10	105 x 241 mm (4.13 x 9.49 inches)	✓	✓
Envelope DL	110 x 220 mm (4.33 x 8.66 inches)	✓	✓
Envelope C5	162 x 229 mm (6.4 x 9 inches)	✓	✓
Envelope B5	176 x 250 mm (6.7 x 9.8 inches)	✓	✓
Envelope C6	114 x 162 mm (4.5 x 6.4 inches)	✓	
Monarch	98.4 x 190.5 mm (3.875 x 7.5 inches)	✓	
Japanese Envelope Chou #3	120 x 235 mm (4.7 x 9.3 inches)	✓	
Japanese Envelope Chou #4	90 x 205 mm (3.5 x 8.1 inches)	✓	

Supported card and label sizes

Size	Dimensions	Tray 1	Tray 2
3x5	(76.2 x 127 mm) (3 x 5 inches)	✓	
4x6	(102 x 152 mm) (4 x 6 inches)	✓	
5x8	(127 x 203 mm) (5 x 8 inches)	✓	
A6	(105 x 148.5 mm) (4.13 x 5.83 inches)	✓	
Double Japan Postcard Rotated	(148 x 200 mm) (5.8 x 7.9 inches)	✓	
Labels (Letter and A4)		✓	✓

Supported photo media sizes

Size	Dimensions	Tray 1	Tray 2
4x6	(102 x 152 mm) (4 x 6 inches)	✓	
10x15cm	(100 x 150 mm) (3.9 x 5.9 inches)	✓	
L	(89 x 127 mm) (3.5 x 5 inches)	✓	
5x7 Photo Media (5 x 7 in no-tabs)	(127 x 178 mm) (5 x 7 inches)	✓	
Photo Media (Letter & A4)		✓	✓
Japanese Postcard	(100 x 148 mm) (3.9 x 5.8 inches)	✓	
Custom	Minimum: 76 x 127 mm (3 x 5 inches) Maximum: 216 x 356 mm (8.5 to 14 inches)	Width: 76 to 216 mm (3 to 8.5 inches) Length: 127 to 356 mm (5 to 14 inches)	Width: 102 to 216 mm (4 to 8.5 inches) Length: 210.06 to 297.2 mm (8.27 to 11.7 inches)

Supported paper types and tray capacity

For best results, use the appropriate paper types and tray capacities:

- [Tray 1 \(multipurpose\) on left side of the product](#)
- [Tray 2 \(default tray\)](#)

Tray 1 (multipurpose) on left side of the product

Paper type	Weight	Capacity ¹	Paper orientation
Every day: <ul style="list-style-type: none">• Unspecified and Plain• HP EcoFFICIENT• Letterhead• Preprinted• Prepunched• Light 60-74g• Intermediate 85-95g• Mid-Weight 96-110g• Heavy 111-130g• HP Premium Presentation Matte 120g• Extra Heavy 131-175g	60 to 175 g/m ² (16 to 47 lb)	Up to 50 sheets	Side to be printed on face-down, with the top edge toward the printer
<ul style="list-style-type: none">• HP Brochure Matte 180g• HP Brochure Glossy 180g• Cardstock 176-220g• HP Cover Matte 200g• HP Advanced Photo Papers	Up to 220 g/m ² (58 lb) ¹	Up to 25 sheets	Side to be printed on face-down
<ul style="list-style-type: none">• Envelope• Heavy Envelope• Labels		Up to 7 envelopes or labels	Side to be printed on face-down

¹ Capacity can vary depending on paper weight and thickness, and environmental conditions.

Tray 2 (default tray)

Paper type	Weight	Capacity ¹	Paper orientation
<ul style="list-style-type: none"> Unspecified and Plain HP EcoFFICIENT Letterhead Preprinted Prepunched Light 60-74g Intermediate 85-95g Mid-Weight 96-110g Heavy 111-130g HP Premium Presentation Matte 120g Extra Heavy 131-175g 	60 to 175 g/m ² (16 to 47 lb)	Up to 500 sheets	Side to be printed on face-up, with the top edge toward the left
<ul style="list-style-type: none"> HP Brochure Matte 180g HP Brochure Glossy 180g Cardstock 176-220g HP Cover Matte 200g HP Advanced Photo Papers 	Up to 220 g/m ² (58 lb)	Up to 100 sheets	Side to be printed on face-up
<ul style="list-style-type: none"> Envelope Heavy Envelope Labels 		Up to 30 envelopes or labels.	Side to be printed on face-up

NOTE: Tray 3 does not support envelope printing.

¹ Capacity can vary depending on paper weight and thickness, and environmental conditions.

Configure trays

By default, the product pulls paper from Tray 2. If Tray 2 is empty, the product pulls paper from Tray 1.



NOTE: If you change the default tray to Tray 1, be sure to configure the tray for the correct paper size and type.

If you use special paper for all or most print jobs on the product, change this default tray setting on the product.

The following table lists possible ways you can use the tray settings to meet your printing needs.

Paper use	Configure the product	Print
Load Tray 1 and one other tray with the same paper, and have the product pick paper from one tray if the other one is empty.	Load paper in Tray 1, and configure the tray for the correct paper and type. Do not use Any Size/Any Type .	From the software program, print the job.
Frequently use special paper, such as heavy paper or letterhead, from one tray.	Load special paper in Tray 1, and configure the tray for the paper type.	From the software program print dialog, choose the paper type that matches the special paper loaded in the tray before sending the print job. Select Tray 1 as the Paper Source from the Paper/Quality tab (Windows) or Paper Feed pop-up menu (OS X).

Load media

- [Load Tray 1](#)
- [Load Tray 2](#)
- [Load envelopes](#)
- [Load letterhead or preprinted forms](#)

Load Tray 1

Tray 1 is the multipurpose tray at the left side of the product.



NOTE: If you are not using Alternate Letterhead Mode (ALM), place the paper with the side to be printed on face-down, with the top edge toward the printer. For ALM orientation, see [Load letterhead or preprinted forms](#).

1. Open Tray 1.



2. Pull out the Tray 1 extension.



3. Open the paper guides completely, and then load the paper stack into Tray 1.



4. Close the paper guides against the loaded media.

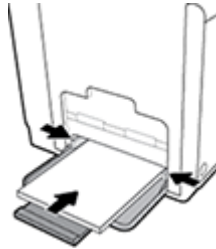

Load Tray 2

Tray 2 is the default (main) paper tray at the front of the product.

 **NOTE:** If you are not using Alternate Letterhead Mode (ALM), place the paper with the side to be printed on face-up, with the top edge toward the left side of the tray. For ALM orientation, see [Load letterhead or preprinted forms](#).

1. Pull the tray out of the product.



2. Open the paper length and width guides completely.

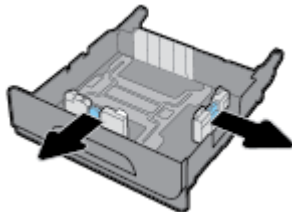

3. Place the paper in the tray and make sure that it is flat at all four corners. Close the length and width paper guides against the loaded media.

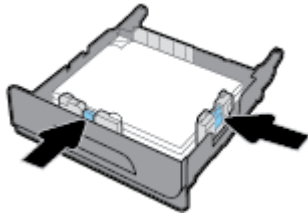

4. Push down on the paper to make sure that the stack is below the paper limit tabs on the side of the tray.

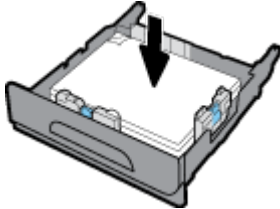

5. Put the tray into the product.



Load envelopes

You can load envelopes into Tray 1 or Tray 2.

To load envelopes into Tray 1

1. Open Tray 1.



2. Pull out the Tray 1 extension.



3. Place envelopes in Tray 1 face-down, with the top of the envelope oriented toward the front of the printer.

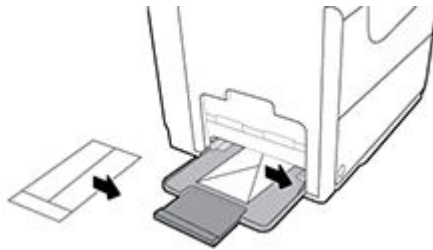

4. Close the paper guides.

To load envelopes into Tray 2

1. Pull the tray out of the product.



2. Stack envelopes face-up, with the top of the envelopes oriented toward the front of the tray.

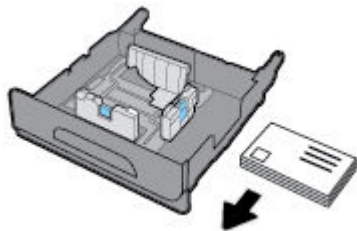

3. Place the envelopes in the tray and make sure that they are flat at all four corners. Close the length and width paper guides against the loaded media.

4. Push down on the envelopes to make sure that the envelopes are below the paper limit tabs on the side of the tray.

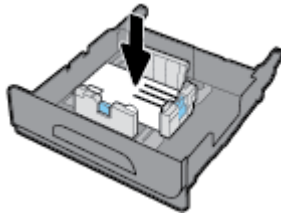

5. Put the tray into the product.

Load letterhead or preprinted forms

You can load letterhead, preprinted, or prepunched forms into any tray. Paper orientation depends on whether you are printing in simplex or duplex mode. If Alternative Letterhead Mode (ALM) is enabled, you can print in both simplex and duplex modes without reorienting the paper.



NOTE: With ALM enabled, you must select Letterhead, Preprinted, or Prepunched as the paper type in the Printer Properties dialog box.

To enable or disable ALM from the control panel

1. Open the control panel dashboard (swipe the dashboard tab at the top of any screen downward, or touch the dashboard area on the home screen).
2. On the control panel dashboard, touch .
3. Touch **Tray and Paper Management**, and then touch **Alternative Letterhead Mode** and turn it on or off.

To enable or disable ALM from the EWS

1. Type the product IP address into the address box of a web browser to open the EWS. (To obtain the product IP, on the control panel dashboard, touch )
2. Click the **Settings** tab.
3. Click **Preferences**, and then click **Tray and Paper Management**.
4. In the **Alternative Letterhead Mode** section, select **Enabled** or **Disabled**.
5. Click **Apply**.

To load letterhead or preprinted forms with ALM enabled

1. Depending on the tray, orient the paper as follows.

Tray 1	Other tray(s)
Place the letterhead face-up, with the top of the page oriented toward the left.	Place the letterhead face-down, with the top of the page oriented toward the right.

2. Complete the steps in [Load Tray 1](#) or [Load Tray 2](#).

To load letterhead or preprinted forms with ALM disabled

1. Depending on the tray, orient the paper as follows.

	Tray 1	Other tray(s)
Simplex	Place the letterhead face-down, with the top of the page oriented toward the right.	Place the letterhead face-up, with the top of the page oriented toward the left.
Duplex	Place the letterhead face-up, with the top of the page oriented toward the left.	Place the letterhead face-down, with the top of the page oriented toward the right.

2. Complete the steps in [Load Tray 1](#) or [Load Tray 2](#).

Tips for selecting and using paper

For the best results, observe the following guidelines.

- Load only one type of paper at a time into the tray.
- Make sure the paper is loaded correctly when loading from the tray.
- Do not overload the tray.
- To prevent jams, poor print quality, and other printing problems, avoid loading the following paper in the tray:
 - Multipart forms
 - Media that is damaged, curled, or wrinkled
 - Media with cutouts or perforations
 - Media that is heavily textured, embossed, or otherwise difficult to print on
 - Media that is too lightweight or stretches easily
 - Media that contains staples or clips

5 Cartridges

- [HP PageWide cartridges](#)
- [Manage cartridges](#)
- [Replace cartridges](#)
- [Tips for working with cartridges](#)

HP PageWide cartridges

HP policy on non-HP cartridges

IMPORTANT:

- HP does not guarantee the quality or reliability of non-HP contents in HP cartridges.
- HP's cartridge warranty does not cover non-HP cartridges or cartridges with non-HP contents.
- HP's printer warranty does not cover repairs or service due to use of non-HP cartridges or cartridges with non-HP contents.

NOTE:

- This printer is not designed to use continuous ink systems. To resume printing, remove the continuous ink system and install original HP (or compatible) cartridges.
 - This printer is designed for cartridges to be used until they are empty. Refilling cartridges before they are depleted might cause your printer to fail. If this happens, insert a new cartridge (either genuine HP or compatible) to continue printing.
-

Counterfeit HP cartridges

Your cartridge might not be a genuine HP cartridge if you notice the following:

- The control panel or printer status report indicates that a used or counterfeit cartridge is installed.
- You are experiencing a high number of problems with the cartridge.
- The cartridge does not look like it usually does (for example, the packaging differs from HP packaging).

Visit the [HP anticounterfeit](#) website when you install an HP print cartridge and the control panel message says the cartridge is used or counterfeit. HP will help resolve the problem.

Manage cartridges

Correctly storing, using, and monitoring cartridges can help ensure high-quality print output and extend the life of cartridges.

- [Store cartridges](#)
- [Print with General Office mode](#)
- [Print when a cartridge is at estimated end of life](#)
- [Check the estimated cartridge levels](#)
- [Order cartridges](#)
- [Recycle cartridges](#)

Store cartridges

- Do not remove the cartridge from its package until you are ready to use it.
- Store cartridges at room temperature (15-35° C or 59-95° F) for at least 12 hours before using them.
- Handle cartridges carefully. Dropping, jarring, or rough handling during installation can cause temporary printing problems.

Print with General Office mode

General Office mode produces slightly lighter printouts, which might extend the life of the cartridge.

1. On the **File** menu in the software program, click **Print**.
2. Make sure your printer is selected.
3. Click the link or button that opens the **Properties** dialog box.

Depending on your software application, this link or button might be called **Properties**, **Options**, **Printer Setup**, **Printer Properties**, **Printer**, or **Set Preferences**.

Do one of the following.

- **Windows:** Click **Print Options**, and then click **Properties**.
 - **OS X:** From the pop-up menu, select **Copies and Pages**.
4. Click the **Paper/Quality** tab.
 5. Select **General Office** from the **Print Quality** drop-down list (Windows) or pop-up menu (OS X).

Print when a cartridge is at estimated end of life

Supply-related notifications are communicated on the printer control panel.

- **Cartridge Low** message appears when a cartridge is nearing the estimated end of its useful life. Printing can continue, but consider having a replacement cartridge available.
- **Cartridge Very Low** message appears when the cartridge is near its estimated end of useful life. Have a replacement cartridge available.
- **Cartridge Depleted** message appears when the cartridge is empty.



NOTE: Although using the **Continue** setting allows printing beyond **Cartridge Very Low** without replacing the cartridge, the product will shut down before any print problems occur.

Check the estimated cartridge levels

You can check the estimated cartridge levels from the printer control panel or from the printer software.

To check the cartridge levels from the control panel

1. Open the control panel dashboard (swipe the dashboard tab at the top of any screen downward, or touch the dashboard area on the home screen).
2. On the control panel dashboard, touch to display the estimated cartridge levels.

To check the cartridge levels from the EWS

1. Open the EWS. For more information, see [Open the EWS](#).
2. Click the **Tools** tab, and then click **Cartridge Level Gauge**.

To check the cartridge levels from the product software (Windows)

1. Open the HP Printer Assistant. For more information, see [Open the HP Printer Assistant](#).
2. On the **Print** tab, click **Maintain Your Printer**.
3. Click the **Estimated Cartridge Levels** tab.

To check the cartridge levels from the product software (OS X)

1. Open HP Utility. For more information, see [Open HP Utility](#).
2. Make sure your printer is selected.
3. Click **Supplies Status**.
The estimated cartridge levels appear.
4. Click **All Settings** to return to the **Information and Support** pane.



NOTE:

- If you have installed a refilled or remanufactured cartridge, or a cartridge that has been used in another printer, the cartridge level indicator might be inaccurate or unavailable.
- Cartridge-level alerts and indicators provide estimates for planning purposes only. When you receive a low-cartridge alert, consider having a replacement cartridge available to avoid possible printing delays. You do not need to replace the cartridges until you are prompted to.
- Ink from the cartridges is used in the printing process in a number of different ways, including in the initialization process, which prepares the printer and cartridges for printing, and in printhead servicing, which keeps the cartridges printing smoothly. Some residual ink is left in the cartridge after it is used. For more information, visit the [HP SureSupply](#) website.

Order cartridges

To order cartridges, visit the [HP website](#). (At this time, some portions of the HP website are available in English only.) Ordering cartridges online is not supported in all countries/regions. However, many countries have information on ordering by telephone, locating a local store, and printing a shopping list. In addition, you can visit the [HP SureSupply](#) website to obtain information about purchasing HP products in your country.

Use only the replacement cartridges that have the same cartridge number as the cartridge you are replacing. You can find the cartridge number in the following places:

- On the label of the cartridge you are replacing.
- On a sticker inside the printer. Open the cartridge access door to locate the sticker.
- In the printer software, open the HP Printer Assistant, click **Shop**, and then click **Shop For Supplies Online**.
- In the HP Embedded Web Server, click the **Tools** tab and then, under **Product Information**, click **Cartridge Level Gauge**. For more information, see [HP Embedded Web Server](#).



NOTE: The SETUP cartridge that comes with the printer is not available for separate purchase.

Recycle cartridges

Visit the [HP sustainability](https://www.hp.com/go/sustainability) website for full information on recycling and to order postage-paid labels, envelopes, and boxes for recycling.

Replace cartridges

The product uses four colors and has a different cartridge for each color: yellow (Y), magenta (M), cyan (C), and black (K).

NOTICE:

- To prevent print-quality problems, HP recommends replacing any missing cartridges with genuine HP cartridges as soon as possible. For more information, see [Order cartridges](#).
- Never turn off the printer if any cartridges are missing.

1. Open the cartridge door.

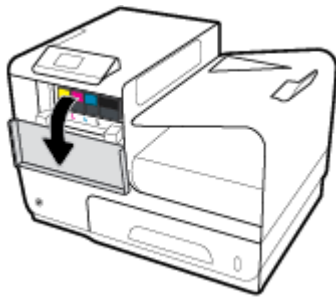

2. Push the old cartridge inward to unlock and release it.

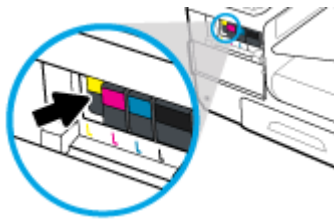

3. Grasp the edge of the old cartridge and then pull the cartridge straight out to remove it.

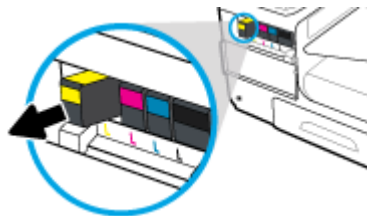

4. Do not touch the metal contacts on the cartridge. Fingerprints on the contacts can cause connection errors.



5. Insert the new cartridge into its slot.

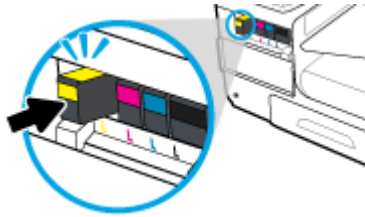

6. Close the cartridge door.



Tips for working with cartridges

Use the following tips to work with cartridges:

- To prevent print-quality problems, do the following:
 - Always turn the printer off using the power button on the front, and wait until the power button light goes out.

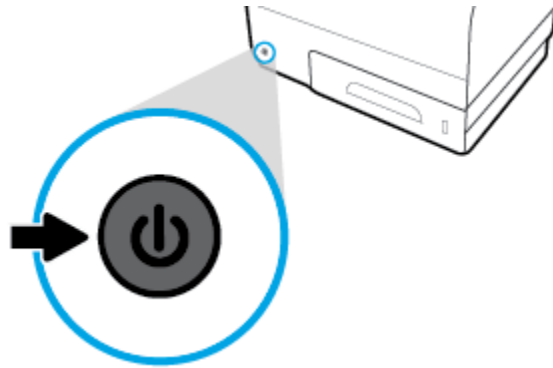

- Make sure that all the cartridge slots are filled.
- If you remove a cartridge from the printer for any reason, try to replace it again as soon as possible.
- Do not open or unpackage cartridges until you are ready to install them.
- Insert the cartridges into the correct slots. Match the color and icon of each cartridge to the color and icon for each slot. Make sure the cartridges snap into place.
- When the Estimated Cartridge Levels screen shows one or more cartridges in a low state, consider getting replacement cartridges to avoid possible printing delays. You do not need to replace the cartridges until prompted to. See [Replace cartridges](#) for more information.
- Do not clean the printhead unnecessarily. This shortens the life of the cartridges.
- If you are transporting the printer, do the following to prevent leaking from the printer or other damage from occurring.
 - Make sure you turn off the printer by pressing the power button in the front. Wait until all sounds of internal motion stop before unplugging the printer.
 - Make sure you leave the cartridges installed.
 - The printer must be transported sitting flat; it should not be placed on its side, back, front, or top.

6 Print

- [Print from a computer](#)
- [Print with HP ePrint](#)
- [Print with AirPrint \(OS X\)](#)
- [Tips for print success](#)

Print from a computer

To print from a computer (Windows)

These instructions apply to printing on various media including the following.

-
- | | | |
|----------------------------------|-------------|-------------|
| • Plain paper | • Envelopes | • Brochures |
| • Letterhead or preprinted forms | • Photos | • Labels |
-

To print from a computer (Windows)

1. Load the supported media in the correct tray.
For more information, see [Supported media sizes](#).
2. On the **File** menu in the software program, click **Print**.
3. Make sure your printer is selected.
4. Click the link or button that opens the **Properties** dialog box.

Depending on your software application, this link or button might be called **Properties**, **Options**, **Printer Setup**, **Printer Properties**, **Printer**, or **Set Preferences**.

5. Set the correct print options for your type of media (plain paper, letterhead or preprinted, envelope, photo paper, label, and so forth).

The following table describes the tabs and options that might be available in your software program.

Tab	Description
Printing Shortcuts	<p>A printing shortcut stores the settings that are appropriate for a particular kind of job, so that you can set all the options with a single click.</p> <p>This tab displays the current printing shortcuts and their settings, such as paper type, paper source, and color or grayscale.</p>
Paper/Quality	<p>This tab contains settings that define the type of print job. For example, printing on envelopes requires different size, source, and type of paper than printing on plain paper.</p> <p>You can select from the following options:</p> <ul style="list-style-type: none">• Paper size: Includes Letter, Envelope #10, and Japanese Envelope Chou #3• Paper source: Includes Printer Auto Select, Manual Feed, Tray 1, and Tray 2• Paper type: Includes Plain, Letterhead, Preprinted, Envelope, HP Advanced Photo Papers, HP Brochure Matte 180g, and Labels <p>NOTE: If Alternative Letterhead Mode (ALM) is enabled, and you are printing on letterhead, preprinted, or prepunched forms, select Letterhead, Preprinted, or Prepunched as the paper type. For more information, see Load letterhead or preprinted forms.</p> <ul style="list-style-type: none">• Special pages: Includes front and back covers, blank sheets, and preprinted sheets• Print quality: Includes Professional (for high-quality jobs) and General Office (for everyday jobs) <p>NOTE: You cannot print envelopes in General Office mode.</p>

Tab	Description
Effects	<p>This tab contains settings that temporarily affect the presentation of the print job.</p> <p>You can select from the following options:</p> <ul style="list-style-type: none"> • Resizing options: Includes actual size, a percentage of actual, or scaled to a specific media size such as Letter or Envelope #10 • Watermarks: Includes Confidential and Draft
Finishing	<p>This tab contains settings that influence the output of the print job.</p> <p>You can select from the following options:</p> <ul style="list-style-type: none"> • Print on both sides: Includes the option to print with room for binding on the left, right, or neither side • Pages per sheet: Print more than one page per sheet, with the option to print borders around each page • Orientation: Includes Portrait and Landscape
Color	<p>This tab contains settings for printing in color or grayscale.</p> <p>You can select from the following:</p> <ul style="list-style-type: none"> • Print in Grayscale: Print in black ink only, or high-quality grayscale (which uses the color cartridges in addition to the black cartridge) • Color Themes: These options determine how colors are rendered. They include various red-green-blue themes such as in Default, Photo, or Vivid. For more information, see To adjust or manage colors.
Advanced	<p>This tab contains settings that you may use or change infrequently.</p> <p>You can select from the following:</p> <ul style="list-style-type: none"> • Copies: Select the number of copies and whether to collate them • Reverse page order: Prints from the last page of the job to the first page • Print all text as black: Helps reduce color cartridge usage • Ink Settings: Use the sliders to select the dry time, saturation level, and black ink spread for the print job. For more information, see To adjust or manage colors.

6. Click **OK** to return to the **Properties** dialog box.
7. Click **OK**, and then click **Print** or click **OK** in the Print dialog box.



NOTE: After printing, remove any special media, such as envelopes or photo paper, from the product.

To print from a computer (OS X)

These instructions apply to printing on various media including the following.

- | | | |
|----------------------------------|-------------|-------------|
| • Plain paper | • Envelopes | • Brochures |
| • Letterhead or preprinted forms | • Photos | • Labels |

To print from a computer (OS X)

1. Load the supported media in the correct tray.
For more information, see [Supported media sizes](#).
2. On the **File** menu in the software program, click **Print**.
3. Make sure your printer is selected.
4. In the **Presets** menu, select a printing preset if needed.
5. On the **Paper/Quality** tab, click the pop-up menu next to the media type.

Set the correct print options for your media (plain paper, letterhead, preprinted, prepunched, envelope, photo paper, label, and so forth). Print options can include size, type, tray, print resolution, and automatic adjustments.

If you do not see options on the Print dialog box, click **Show Details**.

6. Click **Print**.



NOTE: After printing, remove any special media, such as envelopes or photo paper, from the product.

To set up printing shortcuts (Windows)

1. On the **File** menu in the software program, click **Print**.
2. Click the link or button that opens the **Properties** dialog box.

Depending on your software application, this link or button might be called **Properties**, **Options**, **Printer Setup**, **Printer Properties**, **Printer**, or **Set Preferences**.

3. Click the **Printing Shortcuts** tab.
4. Select an existing shortcut as a base.



NOTE: Always select a shortcut before adjusting any of the settings on the right side of the screen. If you adjust the settings and then select a shortcut, all your adjustments are lost.

5. Select the print options for the new shortcut.
6. Click the **Save As** button.
7. Type a name for the shortcut, and click the **OK** button.

To set up printing presets (OS X)

1. On the **File** menu in the software program, click **Print**.
2. Make sure your printer is selected.
3. From the **Presets** pop-up menu, select **Default Settings**.
4. Click **Save Current Settings as Preset**.
5. Type a descriptive name for the preset, and save it for **Only this printer** or **All printers**.

To adjust or manage colors

Adjust the color of print output for the product by changing the settings in the printer driver software.

- [Choose a preset color theme for a print job](#)
- [Adjust the color options for a print job manually](#)
- [Match colors to your computer screen](#)
- [Control access to color printing](#)

Choose a preset color theme for a print job

1. On the **File** menu in the software program, click **Print**.
2. Make sure your printer is selected.
3. Click the link or button that opens the **Properties** dialog box.

Depending on your software application, this link or button might be called **Properties**, **Options**, **Printer Setup**, **Printer Properties**, **Printer**, or **Set Preferences**.

4. Click the **Color** tab, and select a color theme from the **Color Themes** drop-down list (Windows) or the **RGB Color** pop-up menu (OS X).
 - **Default (sRGB)**: This theme sets the product to print RGB data in raw device mode. When using this theme, manage color in the software program or in the operating system for correct rendering.
 - **Vivid**: The product increases the color saturation in the midtones. Use this theme when printing business graphics.
 - **Photo**: The product interprets RGB color as if it were printed as a photograph using a digital mini lab. The product renders deeper, more saturated colors differently than with the Default (sRGB) theme. Use this theme when printing photos.
 - **Photo (Adobe RGB 1998)**: Use this theme with printing digital photos that use the AdobeRGB color space rather than sRGB. Turn off color management in the software program when using this theme.
 - **None**: No color theme is used.

Adjust the color options for a print job manually

Use the printer driver software to clear default color settings and adjust settings manually. Use the built-in help in the driver software to understand how each setting affects print output.

1. On the **File** menu in the software program, click **Print**.
2. Make sure your printer is selected.
3. Do one of the following.
 - **Windows**: Click the link or button that opens the **Properties** dialog box.

Depending on your software application, this link or button might be called **Properties**, **Options**, **Printer Setup**, **Printer Properties**, **Printer**, or **Set Preferences**.

- **OS X**: From the **Copies & Pages** pop-up menu, select **Color**. Then, deselect **HP EasyColor**.

4. Continue to the **Advanced** tab or pane.
 - **Windows:** On the **Advanced** tab, click **Ink Settings**.
 - **OS X:** Click the disclosure triangle next to **Advanced**.
 5. Use the sliders to make the following adjustments.
 - **Dry Time:** Move the slider to the right to increase the amount of time that the printer takes to dry a printed page. Increasing the drying time works best for jobs printed on plain paper.
 - **Saturation:** Move the slider to the right to increase the amount of ink applied. Increasing the saturation works best for jobs printed on brochure or photo paper.
 - **Black Ink Spread:** Move the slider to the left to limit the spread of black ink onto adjacent areas of color on the printed page. Decreasing the spread works best for jobs printed on plain paper.
-
-  **NOTE:** Changing color settings manually can affect output. HP recommends that only color graphics experts change these settings.
-
6. Click **OK** to save your adjustments and close the window, or click **Reset** to return the settings to the factory defaults (Windows).

Match colors to your computer screen

For most users, the best method for matching colors is to print sRGB colors.

The process of matching printer output color to your computer screen is complex, because printers and computer monitors use different methods of producing color. Monitors display colors by using light pixels that use an RGB (red, green, blue) color process, but printers print colors by using a CMYK (cyan, magenta, yellow, and black) process.

Many factors can influence your ability to match printed colors to those on your monitor:

- Print media
- Printing process (cartridge, press, or laser technology, for example)
- Overhead lighting
- Personal differences in perception of color
- Software programs
- Printer drivers
- Computer operating systems
- Monitors
- Video cards and drivers
- Operating environment (humidity, for example)

Control access to color printing

HP's suite of color access control tools allows you to enable or disable color by individual users or groups and applications. For more information, visit the [HP Universal Print Driver](#) website.

Print with HP ePrint

With HP ePrint, you can print anywhere, anytime, from a mobile phone, laptop, or any other mobile device. HP ePrint works with any email-capable device. If you can email, you can print to an HP ePrint-enabled product. For more details, visit the [HP Connected](#) website.

To use HP ePrint, ensure the following:

- You have an Internet- and email-capable computer or mobile device.
- HP Embedded Web Server and HP ePrint are enabled on the printer. For more information, see [HP Embedded Web Server](#).

Print off site by sending an email with the HP ePrint app

If you are on the road, you can print a document by sending an email with the HP ePrint app to your HP ePrint-enabled printer. See [Web Services](#) for more information.

 **NOTE:** Obtain your HP ePrint email address while in the office. For instructions, see [HP ePrint](#).

1. On your computer or mobile device, open your email application.
2. Create a new email message, and then attach the file that you want to print.
3. Enter the HP ePrint email address in the "To" field, and then select the option to send the email message.

 **NOTE:** Do not enter any additional email addresses in either the "To" or "Cc" fields. The HP ePrint server does not accept print jobs if there are multiple email addresses.

Print from an on-site computer or mobile device

If you are at home or in the office, you can print from a smartphone or tablet to your printer easily.

 **NOTE:** If you want to print without accessing the network, see [Use Wi-Fi Direct to connect a computer or device to the product](#) for more information.

1. Make sure your mobile device and printer are on the same network.
2. Select the photo or document you want to print and choose your printer.
3. Confirm print settings and print.

Print with AirPrint (OS X)

Printing using Apple's AirPrint is supported for iPad (iOS 4.2), iPhone (3GS or later), iPod touch (third generation or later), and Mac (OS X v10.9 or later).

To use AirPrint, ensure the following:

- The printer and the Apple device are connected to the same network as your AirPrint-enabled device. For more information, visit the [HP Mobile Printing](#) website. If a local version of this website is not available in your country/region, you might be directed to the HP Mobile Printing site in another country/region or language.
- Load paper that matches the paper settings of the printer.

To re-enable AirPrint

AirPrint is enabled, by default. If it becomes disabled, you can use the following instructions to enable it again.

1. Open the EWS. For more information, see [Open the EWS](#).
2. On the **Network** tab, click **AirPrint** and then click **Status**.
3. In the **AirPrint Status** row, click **Turn On AirPrint**.

Tips for print success

- [Cartridge tips](#)
- [Paper loading tips](#)
- [Printer settings tips \(Windows\)](#)
- [Printer settings tips \(OS X\)](#)

Cartridge tips

- If the print quality is unacceptable, see [Improve print quality](#) for more information.
- Use Original HP cartridges.

Original HP cartridges are designed and tested with HP printers and papers to help you easily produce great results, time after time.



NOTE: HP cannot guarantee the quality or reliability of non-HP cartridges. Product service or repairs required as a result of using a non-HP cartridge will not be covered under warranty.

If you believe you purchased Original HP cartridges, visit the [HP anticounterfeit](#) website.

- Install the black and color cartridges correctly.

For more information, see [Replace cartridges](#).

- Check the estimated cartridge levels to make sure there is sufficient ink.

Supply level warnings and indicators provide estimates for planning purposes only.

For more information, see [Check the estimated cartridge levels](#).



NOTE: When you receive a low-cartridge warning message, consider having a replacement cartridge available to avoid possible printing delays. You do not need to replace the cartridges until prompted to.

- To protect the product from damage, always turn off the printer by using the power button on the front.

Paper loading tips

For more information, see [Supported media sizes](#).

- Ensure the paper is loaded in the input tray properly, and set the correct media size and media type. Upon loading paper in input tray, you will be prompted to set the media size and media type.
- Load a stack of paper (not just one page). All the paper in the stack should be of the same size and type to avoid a paper jam.
- Ensure that paper loaded in the input tray lays flat and the edges are not bent or torn.
- Adjust the paper-width guides in the input tray to fit snugly against all paper. Make sure the guides do not bend the paper in the tray.

Printer settings tips (Windows)

- To change default print settings, do one of the following:

- In the HP Printer Assistant, click **Print** , and then click **Set Preferences**. For more information, see [Open the HP Printer Assistant](#).
- On the **File** menu in the software program, click **Print**. Open the Printer Properties dialog box.
- On the **Color** or **Finishing** tab of the printer driver, set the following options as needed:
 - **Print in Grayscale**: Allows you to print a black-and-white document using only the black cartridge. Click **Black Ink Only**, and then click **OK** .
 - **Pages per sheet**: Helps you specify the order of the pages if you print document in more than two pages per sheet.
 - **Booklet Layout**: Allows you to print a multiple-page document as a booklet. It places two pages on each side of a sheet that can then be folded into a booklet in half size of the paper. Select a binding method from the drop-down list, and then click **OK** .
 - **Left binding**: The binding side after folded into a booklet appears at the left side. Select the option if your reading habit is from left to right.
 - **Right binding**: The binding side after folded into a booklet appears at the right side. Select the option if your reading habit is from right to left.
 - **Print page borders**: Allows you to add the borders to the pages if you print the document with two or more pages per sheet.
- You can use printing shortcuts to save time setting printing preferences.

Printer settings tips (OS X)

- In the software program, be sure to select the correct paper size loaded in the printer.
 - a. From the **File** menu, select **Page Setup**.
 - b. In **Format For**, make sure your printer is selected.
 - c. From the pop-up menu, select **Paper Size**.
- In the software program, be sure to select the correct paper type and quality loaded in the printer.
 - a. On the **File** menu in the software program, click **Print**.
 - b. From the **Copies & Pages** pop-up menu, select **Paper/Quality**, and select the correct paper type and quality.
- To print a black-and-white document using only the black cartridge, do the following.
 - a. On the **File** menu in the software program, click **Print**.
 - b. In the Print window, from the pop-up menu, select **Copies & Pages**, and then select **Color**.
 - c. Deselect **HP EasyColor**, and then select **Print Color as Gray**.
 - d. Select **Black Ink Only**.

7 Solve problems

- [Problem-solving checklist](#)
- [Information pages](#)
- [Factory-set defaults](#)
- [Cleaning routines](#)
- [Jams and paper-feed issues](#)
- [Cartridge issues](#)
- [Printing issues](#)
- [Connectivity issues](#)
- [Wireless network issues](#)
- [Product software issues \(Windows\)](#)
- [Product software issues \(OS X\)](#)

Problem-solving checklist

Follow these steps when trying to solve a problem with the product.

- [Check that the product power is on](#)
- [Check the control panel for error messages](#)
- [Test print functionality](#)
- [Try sending a print job from a computer](#)
- [Factors that affect product performance](#)

Check that the product power is on

1. If the power button is not lit, press it to turn the product on.
2. If the power button does not seem to work, ensure that the power cable is connected to both the product and the electrical or AC outlet.
3. If the product is still not powering up, check the power source by connecting the power cable to a different electrical or AC outlet.

Check the control panel for error messages

The control panel should indicate ready status. If an error message appears, resolve the error.

Test print functionality

1. Open the control panel dashboard (swipe the dashboard tab at the top of any screen downward, or touch the dashboard area on the home screen).
2. On the control panel dashboard, touch .
3. Touch [Reports](#), and then touch [Printer Status Report](#) to print a test page.
4. If the report does not print, make sure paper is loaded in the tray, and check the control panel to see if paper is jammed inside the product.



NOTE: Make sure the paper in the tray meets specifications for this product.

Try sending a print job from a computer

1. Use a word-processing program to send a print job to the product.
2. If the job does not print, make sure you selected the correct printer driver.
3. Uninstall and then reinstall the product software.

Factors that affect product performance

Several factors affect the time it takes to print a job:

- The software program that you are using and its settings
- The use of special paper (such as heavy paper and custom-size paper)

- Product processing and download time
- The complexity and size of graphics
- The speed of the computer you are using
- The USB or network connection
- Whether the product is printing in color or in monochrome
- The type of USB drive, if you are using one

Information pages

Information pages reside within the product memory. These pages help diagnose and solve problems with the product.



NOTE: If the product language was not correctly set during installation, you can set the language manually so the information pages print in one of the supported languages. Change the language by using the [Preferences](#) menu on the [Setup](#) menu in the control panel or by using the HP Embedded Web Server.

1. Open the control panel dashboard (swipe the dashboard tab at the top of any screen downward, or touch the dashboard area on the home screen).
2. On the control panel dashboard, touch .
3. Touch [Reports](#) to view the menu.
4. Touch the name of the report that you want to print.

Menu Item	Description
Printer Status Report	<p>Prints the cartridge status. Includes the following information:</p> <ul style="list-style-type: none"> • Estimated proportion of cartridge life remaining <p>NOTE: Cartridge-level alerts and indicators provide estimates for planning purposes only. When you receive a low-cartridge alert, consider having a replacement cartridge available to avoid possible printing delays. You do not need to replace the cartridges until you are prompted to.</p> <ul style="list-style-type: none"> • Approximate number of pages remaining • Part numbers for HP cartridges • Number of pages printed • Information about ordering new HP cartridges and recycling used HP cartridges
Print Quality Report	Prints a page that helps solve problems with print quality
Web Access Test Report	Shows the current configuration settings and diagnostic results for the local network, gateway, DNS, proxy, and test server. This report is useful for resolving problems accessing the web.
Usage Page	Shows a count of all paper sizes that have passed through the product; lists whether they were monochrome or color, simplex or duplex, and reports the page count. This report is useful for reconciling contractual billing statements.

Menu Item	Description
Network Configuration Page	Displays status for: <ul style="list-style-type: none"> • Network hardware configuration • Enabled features • TCP/IP and SNMP information • Network statistics • Wireless network configuration (wireless models only)
Event Log	Prints a log of errors and other events during product use.
PCL Font List	Prints a list of all installed PCL fonts
PCL6 Font List	Prints a list of all installed PCL6 fonts
PS Font List	Prints a list of all installed PS fonts

Factory-set defaults

NOTICE: Restoring the factory-set defaults returns all of the product and network settings to the factory defaults. The procedure then automatically restarts the product.

1. Open the control panel dashboard (swipe the dashboard tab at the top of any screen downward, or touch the dashboard area on the home screen).
2. On the control panel dashboard, touch .
3. Touch [Printer Maintenance](#), and then touch [Restore](#).
4. Touch [Restore Factory Defaults](#), and then touch [Continue](#).

The product automatically restarts.

Cleaning routines

- [Clean the printhead](#)
- [Clean the touch screen](#)

Clean the printhead

During the printing process, paper, ink, and dust particles can accumulate inside the product. Over time, this buildup can cause print-quality problems such as specks or smearing.

This product automatically services itself, running cleaning routines that can correct most of these problems.

For problems that the product cannot automatically solve, use the following routine to clean the printhead.



NOTE: This routine uses ink to clean the printhead. Use the routine only to correct print quality errors. Do not use it for periodic maintenance.

 **TIP:** Turning the product off properly by pressing the power button on the front of the product helps keep the printhead from clogging and creating print-quality problems.

1. Open the control panel dashboard (swipe the dashboard tab at the top of any screen downward, or touch the dashboard area on the home screen).
2. On the control panel dashboard, touch .
3. Touch **Printer Maintenance** to view the list of cleaning and alignment routines.
4. Touch **Clean Printhead Level 1**, and then follow the prompts on the control panel. If necessary, load paper in the requested tray.

A page feeds through the product slowly. Discard the page when the process is completed.

5. If the printhead is still not clean, touch **Clean Printhead Level 2**, and follow the prompts on the control panel. If that does not work, continue with the next cleaning routine. Continue down the list of cleaning routines, if needed.

A page feeds through the product slowly. Discard the page when the process is completed.

Clean the touch screen

Clean the touch screen whenever it is necessary to remove fingerprints or dust. Wipe the touch screen gently with a clean, water-dampened, lint-free cloth.

NOTICE: Use water only. Solvents or cleaners can damage the touch screen. Do not pour or spray water directly onto the touch screen.

Jams and paper-feed issues

Try these steps to solve paper-handling problems.

The product does not pick up paper

If the product does not pick up paper from the tray, try these solutions.

1. Open the product and remove any jammed sheets of paper.
2. Load the tray with the correct size of paper for your job.
3. Make sure the paper guides in the tray are adjusted correctly for the size of paper. Align the guides with the paper-size markings in the bottom of the tray.
4. Remove the stack of paper from the tray and flex it, rotate it 180 degrees, and flip it over. *Do not fan the paper.* Return the stack of paper to the tray.
5. Check the control panel to see if the product is waiting for you to acknowledge a prompt to feed the paper manually through Tray 1, the multipurpose tray on the left side of the product. Load paper, and continue.

The product picks up multiple sheets of paper

If the product picks up multiple sheets of paper from the tray, try these solutions.

1. Remove the stack of paper from the tray and flex it, rotate it 180 degrees, and flip it over. *Do not fan the paper.* Return the stack of paper to the tray.
2. Use only paper that meets HP specifications for this product.
3. Use paper that is not wrinkled, folded, or damaged. If necessary, use paper from a different package. Make sure all paper in the tray is the same type and size.
4. Make sure the tray is not overfilled. If it is, remove the entire stack of paper from the tray, straighten the stack, and then return less paper to the tray.

Even if the tray is not overfilled, try using a lower stack of media, such as half.
5. Make sure the paper guides in the tray are adjusted correctly for the size of paper. Align the guides with the paper-size markings in the bottom of the tray.
6. Print from another tray.

Prevent paper jams

To reduce the number of paper jams, try these solutions.

1. Use only paper that meets HP specifications for this product. Lightweight, short-grain paper is not recommended.
2. Use paper that is not wrinkled, folded, or damaged. If necessary, use paper from a different package.
3. Use paper that has not previously been printed or copied on.
4. Make sure the tray is not overfilled. If it is, remove the entire stack of paper from the tray, straighten the stack, and then return some of the paper to the tray.

5. Make sure the paper guides in the tray are adjusted correctly for the size of paper. Adjust the guides so they are touching the paper stack without bending it.
6. Make sure that the tray is fully inserted in the product.
7. If you are printing on heavy, embossed, or perforated paper, use Tray 1, the multipurpose tray on the left side of the printer, and then feed sheets manually one at a time.

Clear jams

- [Jam locations](#)
- [Clear jams in Tray 1 \(multipurpose tray\)](#)
- [Clear jams in Tray 2](#)
- [Clear jams in the left door](#)
- [Clear jams in the output bin](#)
- [Clear jams in the duplexer](#)



NOTE: For best results, do not turn off the product before clearing paper jams.

Jam locations

Jams can occur in these locations:

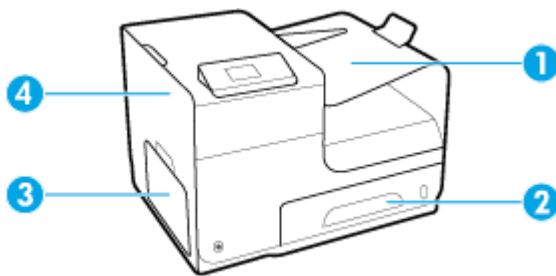

1	Output bin
2	Tray 2
3	Tray 1
4	Left door

Traces of ink might remain in the product after a jam. This problem typically resolves itself after a few sheets have been printed.

Clear jams in Tray 1 (multipurpose tray)

- ▲ If the jammed sheet is visible and easily accessible in Tray 1, pull it from Tray 1.



NOTE: If the sheet tears, make sure that all of the fragments are removed before you resume printing.



Clear jams in Tray 2

1. Open Tray 2 by pulling it out and releasing the latch at the rear left of the tray.



2. Remove the jammed sheet by pulling it to the right and then out of the product.

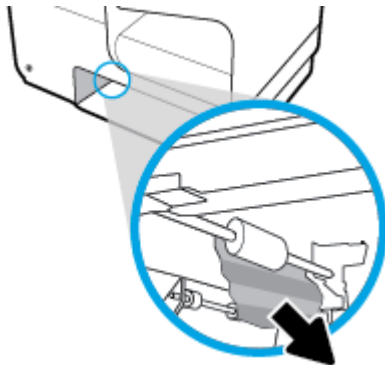

3. Close Tray 2.

 **NOTE:** To close the tray, push in the middle or with even pressure on both sides. Avoid pushing on one side only.



Clear jams in the left door

1. Open the left door.

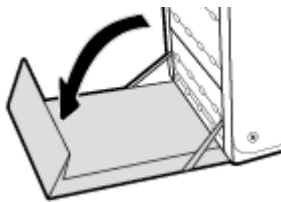

2. Gently remove any visible paper from the rollers and delivery area.

 **NOTE:** If the sheet tears, make sure that all fragments are removed before you resume printing. Do not use sharp objects to remove fragments.

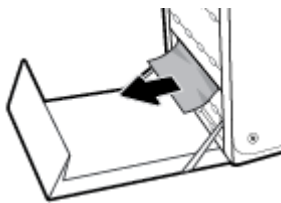

3. Close the left door.

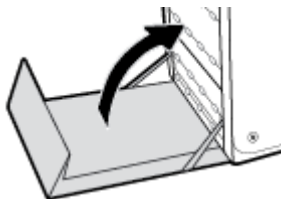

Clear jams in the output bin

1. Look for jammed paper in the output bin area.

2. Remove any visible media.



NOTE: If the sheet tears, remove all fragments before you resume printing.

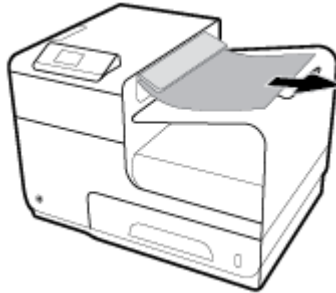

3. Open and then close the left door to clear the message.

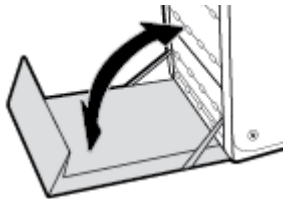

Clear jams in the duplexer

1. Open the left door.

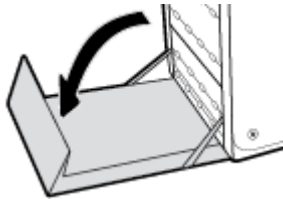

2. Remove the duplexer by pulling it out with both hands. Set the duplexer aside, upright, on a piece of paper to prevent spills.

NOTICE: When pulling out the duplexer, avoid making direct contact with the black cylinder to prevent ink smear on skin or clothes.

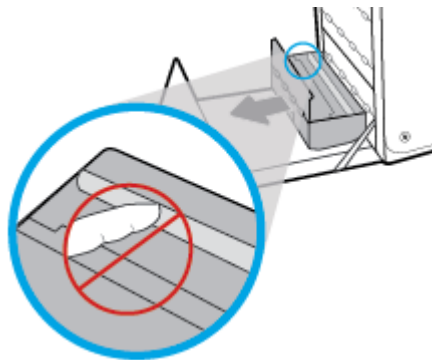

3. Lower the platen by pressing down on the green tab. This will cause the product to try to feed the sheet through the print zone. You may need to gently pull on the sheet if it does not feed. Remove the sheet.

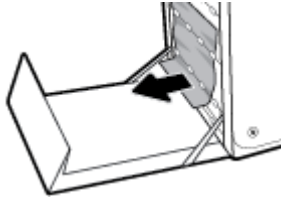

4. Lift the green tab to place the platen back into its operating position.

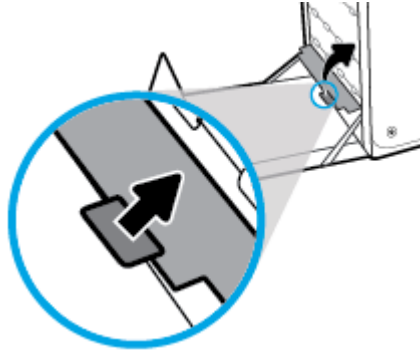

5. Reinstall the duplexer.

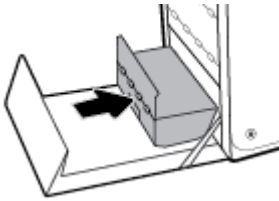

6. Close the left door.

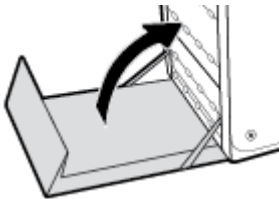

Cartridge issues

Refilled or remanufactured cartridges

HP cannot recommend the use of non-HP supplies, either new or remanufactured. Because they are not HP products, HP cannot influence their design or control their quality. If you are using a refilled or remanufactured cartridge and are not satisfied with the print quality, replace the cartridge with a genuine HP cartridge.



NOTE: If you replace a non-HP cartridge with a genuine HP cartridge, the printhead may still contain non-HP ink until the printhead is depleted of that ink and is supplied with ink from the newly installed, genuine HP cartridge. Until the non-HP ink is depleted, print quality will be affected.

Interpret control panel messages for cartridges

Cartridge Depleted

Description

The cartridge is at the end of its useful life, and the product will no longer print.

Recommended action

Depleted cartridges must be replaced to resume printing.

Cartridge Low

Description

The cartridge is nearing the end of its useful life.

Recommended action

Printing can continue, but consider having a replacement cartridge on hand. You do not need to replace the cartridges until prompted to.

Cartridge Very Low

Description

The cartridge is near the end of its useful life.

Recommended action

Have a replacement cartridge on hand. You do not need to replace the cartridges until prompted to.

Counterfeit or used [color] cartridge installed

Description

The original HP ink in this cartridge has been depleted.

Recommended action

Click OK to continue printing or replace with genuine HP cartridge.

Do not use SETUP cartridges

Description

SETUP cartridges cannot be used after the device has been initialized.

Recommended action

Remove and install non-SETUP cartridges.

Genuine HP cartridge installed

Description

A genuine HP cartridge was installed.

Recommended action

No action necessary.

Incompatible [color]**Description**

You have installed a cartridge that is intended for use in a different HP product model. The product will NOT function with this print cartridge installed.

Recommended action

Install the correct cartridge for this product.

Incompatible cartridges**Description**

- The contacts on the cartridge might not be making a connection to the printer.
- The cartridge is not compatible with your printer.

Recommended action

- Carefully clean the contacts on the cartridge by using a soft, lint-free cloth and insert the cartridge again.
- Remove this cartridge immediately and replace with a compatible cartridge.

Install [color] cartridge**Description**

This message can appear during the initial set up of the product and may also appear after the initial set up of the product has been completed.

If this message appears during initial setup, it means one of the color cartridges is not installed with the door closed. The product will not print if a cartridge is missing.

If this message appears after the initial setup of the product, it means that the cartridge is missing or is installed but damaged.

Recommended action

Install or replace the indicated color cartridge.

Non-HP cartridges installed**Description**

No action necessary, this is a notification only.

Recommended action

No action necessary, this is a notification only.

However, HP cannot recommend the use of non-HP supplies, either new or remanufactured. Touch **OK** to continue printing or replace the cartridge with a genuine HP cartridge.

Printer Failure

Description

The printer refuses to function.

Recommended action

Have a replacement cartridge on hand. You do not need to replace the cartridges until prompted to.

Problem with Print System

Description

The cartridge identified in the message is missing, damaged, incompatible, or inserted into the wrong slot in the printer.

Recommended action

Printing functionality is disabled. Visit the [HP Customer Support](#) website.

Problem with Printer Preparation

Description

The printer clock has failed and cartridge preparation may not be complete. The estimated Cartridge Level gauge might be inaccurate.

Recommended action

Check the print quality of your print job. If it is not satisfactory, running the printhead cleaning procedure from the toolbox might improve it.

Problem with SETUP cartridges

Description

There is a problem with the SETUP cartridges and the printer cannot complete system initialization.

Recommended action

Visit the [HP Customer Support](#) website.

Use SETUP cartridges

Description

The SETUP cartridges have been removed before the product has completed initialization.

Recommended action

Use the SETUP cartridges that came with your product for product initialization.

When you first set up the printer, you must install the SETUP cartridges that shipped in the box with the printer. These cartridges calibrate your printer before the first print job. Failure to install the SETUP cartridges during the initial product setup causes an error. If you installed a set of regular cartridges, remove them and install the SETUP cartridges to complete printer setup. After printer setup is complete, the printer can use regular cartridges.

If you still receive error messages and the printer cannot complete system initialization, visit the [HP Customer Support](#) website.

Used [color] installed

Description

A used, but still genuine, HP color cartridge has been installed or moved.

Recommended action

You have a used, but still genuine, HP cartridge installed. No action required.

Printing issues

The product does not print

If the product does not print at all, try the following solutions.

1. Make sure the product is turned on and that the control panel indicates it is ready.
 - If the control panel does not indicate the product is ready, turn the product off and then on again.
 - If the control panel indicates the product is ready, try sending the job again.
2. If the control panel indicates the product has an error, resolve the error and then try to print a test page from the control panel. If the test page prints, there may be a communication problem between the product and the computer you are trying to print from.
3. Make sure the cables are all connected correctly. If the product is connected to a network, check the following items:
 - Check the light next to the network connection on the product. If the network is active, the light is green.
 - Make sure that you are using a network cable and not a phone cord to connect to the network.
 - Make sure the network router, hub, or switch is turned on and that it is working correctly.
4. Install the HP software from 123.hp.com/pagewide (recommended) or from the HP software CD provided with the printer. Using generic printer drivers can cause delays clearing jobs from the print queue.
5. From the list of printers on your computer, right-click the name of this product, click **Properties**, and open the **Ports** tab.
 - If you are using a network cable to connect to the network, make sure the printer name listed on the **Ports** tab matches the product name on the product configuration page.
 - If you are using a USB cable and are connecting to a wireless network, make sure the box is checked next to **Virtual printer port for USB**.
6. If you are using a personal firewall system on the computer, it might be blocking communication with the product. Try temporarily disabling the firewall to see if it is the source of the problem.
7. If your computer or the product is connected to a wireless network, low signal quality or interference might be delaying print jobs.

The product prints slowly

If the product prints, but it seems slow, try the following solutions.

- Make sure the computer meets the minimum specifications for this product. For a list of specifications, visit [HP Customer Support](#).
- If the paper type setting is not correct for the type of paper you are using, change the setting to the correct paper type.
- If your computer or the product is connected to a wireless network, low signal quality or interference might be delaying print jobs.
- If Quiet Mode is on, turn it off. This mode slows down the print speed. For more information, see [Quiet Mode](#).

Improve print quality

You can prevent most print-quality problems by following these guidelines.

- [Check for genuine HP cartridges](#)
- [Use paper that meets HP specifications](#)
- [Use the correct paper type setting in the printer driver](#)
- [Use the printer driver that best meets your printing needs](#)
- [Align the printhead](#)
- [Print a print-quality report](#)

Check for genuine HP cartridges

Your cartridge may not be a genuine HP cartridge. For more information, see [Counterfeit HP cartridges](#). Replace it with a genuine HP cartridge.

Use paper that meets HP specifications

Use different paper if you are having any of the following problems:

- The printing is too light or seems faded in areas.
- Specks of ink are on the printed pages.
- Ink smears on the printed pages.
- Printed characters seem misformed.
- Printed pages are curled.

Always use a paper type and weight that this product supports. In addition, follow these guidelines when selecting paper:

- Use paper that is of good quality and free of cuts, nicks, tears, spots, loose particles, dust, wrinkles, voids, staples, and curled or bent edges.
- Use paper that has not been previously printed on.

- Use paper that is designed for use in PageWide printers.
- Use paper that is not too rough. Using smoother paper generally results in better print quality.



NOTE: Based on HP internal testing using a range of plain papers, HP highly recommends using papers with the ColorLok® logo for this product. For details, visit the [HP print permanence](#) website.



Use the correct paper type setting in the printer driver

Check the paper type setting if you are having any of the following problems:

- Ink smears on the printed pages.
- Repeated marks occur on the printed pages.
- Printed pages are curled.
- Printed pages have small unprinted areas.

Change the paper type and size setting (Windows)

1. On the **File** menu in the software program, click **Print**.
2. Select the product, and then click the **Properties** or **Preferences** button.
3. Click the **Paper/Quality** tab.
4. From the **Paper Type** drop-down list, click **More**.
5. Expand the list of **Type Is** options.
6. Expand each category of paper types until you find the paper type that you are using.
7. Select the option for the type of paper you are using, and click **OK**.

Change the paper type and size setting (OS X)

1. From the **File** menu, select **Page Setup**.
2. In **Format For:**, make sure your printer is selected.
3. From the **Paper Size** pop-up menu, select the correct size.
4. From the **Copies & Pages** pop-up menu, select **Paper/Quality**.
5. From the **Media type:** pop-up menu, select the correct media type.

Use the printer driver that best meets your printing needs

You might need to use a different printer driver if the printed page has unexpected lines in graphics, missing text, missing graphics, incorrect formatting, or substituted fonts.

HP PCL 6 driver	<ul style="list-style-type: none"> • Provided as the default driver. This driver is automatically installed when installing the product from 123.hp.com/pagewide (recommended) or from the HP software CD provided with the printer. • Recommended for all Windows environments. For Windows 7 and later, this driver is XPS-based. For Windows 2003, XP, and Vista, a more basic PCL 6 print driver is provided. • Provides the overall best speed, print quality, and product-feature support for most users.
HP UPD PS driver	<ul style="list-style-type: none"> • Recommended for printing with Adobe® software programs or with other highly graphics-intensive software programs. • Provides support for printing from postscript emulation needs, or for postscript flash font support. • This driver is available for download at HP Universal Print Driver.
HP UPD PCL 6	<ul style="list-style-type: none"> • Recommended for printing in all Windows environments. • Provides the overall best speed, print quality, and printer feature support for users in managed environments. • Developed to align with Windows Graphic Device Interface (GDI) for best speed in Windows environments. • This driver is available for download at HP Universal Print Driver.



NOTE: Download additional printer drivers from the [HP Customer Support](#) website.

Align the printhead

1. Open the control panel dashboard (swipe the dashboard tab at the top of any screen downward, or touch the dashboard area on the home screen).
2. On the control panel dashboard, touch .
3. Touch [Printer Maintenance](#), and then touch [Align Printhead](#).

Print a print-quality report

Run a Print Quality report and follow the instructions. For more information, see [Information pages](#).

Connectivity issues

Solve USB direct-connect problems

If you have connected the product directly to a computer, check the USB cable.

- Verify that the cable is connected to the computer and to the product.
- Verify that the cable is not longer than 5 m (16.4 ft). Try using a shorter cable.
- Verify that the cable is working correctly by connecting it with another product. Replace the cable if necessary.

Solve network problems

Check the following items to verify that the product is communicating with the network. Before beginning, print a configuration page from the control panel and locate the product IP address that is listed on this page.

- [Poor physical connection](#)
- [The computer is using the incorrect IP address for the product](#)
- [The computer is unable to communicate with the product](#)
- [The product is using incorrect link and duplex settings for the network](#)
- [New software programs might be causing compatibility problems](#)
- [The computer or workstation might be set up incorrectly](#)
- [The product is disabled, or other network settings are incorrect](#)

Poor physical connection

1. Verify that the product is attached to the correct ethernet port using the proper cable.
2. Verify that cable connections are securely attached.
3. Look at the Ethernet port on the back of the product, and verify that the amber activity light and the green link-status light are active.
4. If the problem continues, try a different cable or port on the network router, switch, or hub.

The computer is using the incorrect IP address for the product

1. On the computer, open the printer properties and click the **Ports** tab. Verify that the current IP address for the product is selected. The product IP address is listed on the product configuration page or through the control panel.
2. If you installed the product using an HP standard TCP/IP port, select the box labeled **Always print to this printer, even if its IP address changes**.
3. If you installed the product using a Microsoft standard TCP/IP port, use the hostname instead of the IP address.

If you installed the product from 123.hp.com/pagewide (recommended) or from the HP software CD provided with the printer, you can view or change the product IP address using the following steps:

- a. Open the HP Printer Assistant. For more information, see [Open the HP Printer Assistant](#).
 - b. Click the **Tools** tab.
 - c. Click **Update IP Address** to open a utility that reports the known (“previous”) IP address for the product and allows you to change the IP address, if necessary.
4. If the IP address is correct, delete the product entry from the list of installed printers, and then add it again.

The computer is unable to communicate with the product

1. Test network communication by pinging the product.

- a. Open a command-line prompt on your computer. For Windows, click **Start** , click **Run**, and then type `cmd`.
 - b. Type `ping` followed by the IP address for your product.
 - c. If the window displays round-trip times, both the network and device are working.
2. If the ping command failed, verify that the network router, hubs, or switches are on, and then verify that the network settings, the product, and the computer are all configured for the same network.

The product is using incorrect link and duplex settings for the network

HP recommends leaving this setting in automatic mode (the default setting). If you change these settings, you must also change them for your network.

New software programs might be causing compatibility problems

Verify that any new software programs are correctly installed and that they use the correct printer driver.

The computer or workstation might be set up incorrectly

1. Check the network drivers, printer drivers, and the network redirection.
2. Verify that the operating system is configured correctly.

The product is disabled, or other network settings are incorrect

1. Review the configuration page to check the status of the network protocol. Enable it if necessary.
2. Reconfigure the network settings if necessary.

Wireless network issues

Wireless connectivity checklist

- The product and the wireless router are turned on and have power. Also make sure the wireless radio in the product is turned on.
- The service set identifier (SSID) is correct. Print a configuration page to determine the SSID. If you are not sure the SSID is correct, run the wireless setup again.
- With secured networks, make sure the security information is correct. If the security information is incorrect, run the wireless setup again.
- If the wireless network is working correctly, try accessing other computers on the wireless network. If the network has Internet access, try connecting to the Internet over another wireless connection.
- The encryption method (AES or TKIP) is the same for the product as it is for the wireless access point, such as a wireless router (on networks using WPA security).
- The product is within the range of the wireless network. For most networks, the product must be within 30 m (100 ft) of the wireless access point (wireless router).
- Obstacles do not block the wireless signal. Remove any large metal objects between the access point and the product. Make sure poles, walls, or support columns containing metal or concrete do not separate the product and wireless access point.

- The product is located away from electronic devices that might interfere with the wireless signal. Many devices can interfere with the wireless signal including motors, cordless phones, security system cameras, other wireless networks, and some Bluetooth devices.
- The printer driver is installed on the computer.
- You have selected the correct printer port.
- The computer and product connect to the same wireless network.

The product does not print, and the computer has a third-party firewall installed

1. Update the firewall with the most recent update available from the manufacturer.
2. If programs request firewall access when you install the product or try to print, make sure you allow the programs to run.
3. Temporarily turn off the firewall, and then install the wireless product on the computer. Enable the firewall when you have completed the wireless installation.

The wireless connection does not work after moving the wireless router or product

Make sure that the router or product connects to the same network that your computer connects to.

1. Open the control panel dashboard (swipe the dashboard tab at the top of any screen downward, or touch the dashboard area on the home screen).
2. On the control panel dashboard, touch .
3. Touch [Reports](#), and then touch [Network Configuration Page](#) to print the report.
4. Compare the service set identifier (SSID) on the configuration report to the SSID in the printer configuration for your computer.
5. If the SSIDs are not the same, the devices are not connecting to the same network. Reconfigure the wireless setup for your product.

Cannot connect more computers to the wireless product

1. Make sure that the other computers are within the wireless range and that no obstacles block the signal. For most networks, the wireless range is within 30 m (100 ft) of the wireless access point.
2. Make sure the product is turned on and in the ready state.
3. Turn off any third-party firewalls on your computer.
4. Make sure that the wireless network is working correctly.
 - a. Open the control panel dashboard (swipe the dashboard tab at the top of any screen downward, or touch the dashboard area on the home screen).
 - b. On the control panel dashboard, touch .
 - c. Touch [Reports](#), and then touch [Web Access Report](#) to print the report.
5. Make sure that the correct port or product is selected.
 - For printers installed *without* the fully featured installer:

- a. From the list of printers on your computer, right-click the name of this product, click **Printer Properties**, and then open the **Ports** tab.
 - b. Make sure the box is checked next to **Virtual printer port for USB**.
- If you installed the printer software from 123.hp.com/pagewide (recommended) or from the HP software CD provided with the printer, you can view or change the product IP address using the following steps:
 - a. Click **Start**.
 - b. Click **All Programs**.
 - c. Click **HP**.
 - d. Click your product.
 - e. Click **Update IP Address** to open a utility that reports the known (“previous”) IP address for the product and allows you to change the IP address, if necessary.
- 6. Make sure that your computer is working correctly. If necessary, restart your computer.

The wireless product loses communication when connected to a VPN

- Typically, you cannot connect to a VPN and other networks at the same time.

The network does not appear in the wireless networks list

- Make sure the wireless router is turned on and has power.
- The network might be hidden. However, you can still connect to a hidden network.

The wireless network is not functioning

1. To verify if the network has lost communication, try connecting other devices to the network.
2. Test network communication by pinging the network.
 - a. Open a command-line prompt on your computer. For Windows, click **Start**, click **Run**, and then type `cmd`.
 - b. Type `ping` followed by the service set identifier (SSID) for your network.
 - c. If the window displays round-trip times, the network is working.
3. To make sure that the router or product connects to the same network that your computer connects to, print the Network Configuration Page. For instructions, see [Information pages](#).

Product software issues (Windows)

Problem	Solution
A printer driver for the product is not visible in the Printer folder	<ul style="list-style-type: none"> • Reinstall the product software.

Problem	Solution
	<p>NOTE: Close any applications that are running. To close an application that has an icon in the system tray, right-click the icon, and select Close or Disable.</p> <ul style="list-style-type: none"> • Try plugging the USB cable into a different USB port on the computer.
An error message was displayed during the software installation	<ul style="list-style-type: none"> • Reinstall the product software. <p>NOTE: Close any applications that are running. To close an application that has an icon in the task bar, right-click the icon, and select Close or Disable.</p> <ul style="list-style-type: none"> • Check the amount of free space on the drive where you are installing the product software. If necessary, free up as much space as you can, and reinstall the product software. • If necessary, run the Disk Defragmenter, and reinstall the product software.
The product is in Ready mode, but nothing prints	<ul style="list-style-type: none"> • Print a configuration page from the control panel, and verify the product functionality. • Verify that all of the cables are correctly seated and within specifications. This includes the USB and power cables. Try a new cable. • Verify the IP Address on the Configuration Page matches the IP address for the software port. Use one of the following procedures: <ul style="list-style-type: none"> ◦ Windows XP, Windows Server 2003, Windows Server 2008, and Windows Vista, installed without using the fully featured installer (such as Add Printer Wizard in Windows): <ol style="list-style-type: none"> 1. Click Start. 2. Click Settings. 3. Click Printers. 4. Right-click the product driver icon, and then select Properties. 5. Click the Ports tab, and then click Configure Port. 6. Verify the IP address, and then click OK or Cancel. 7. If the IP Addresses are not the same, delete the driver, and reinstall the driver using the correct IP address. ◦ Windows 7, installed without using the fully featured installer (such as Add Printer Wizard in Windows): <ol style="list-style-type: none"> 1. Click Start. 2. Click Devices and Printers. 3. Right-click the product driver icon, and then select Printer properties. 4. Click the Ports tab, and then click Configure Port. 5. Verify the IP address, and then click OK or Cancel. 6. If the IP Addresses are not the same, delete the driver, and reinstall the driver using the correct IP address. ◦ Windows XP, Windows Server 2003, Windows Server 2008, Windows Vista, and Windows 7, installed using the fully featured installer: <ol style="list-style-type: none"> 1. Click Start. 2. Click All Programs. 3. Click HP.

Problem	Solution
	<ol style="list-style-type: none">4. Click your product.5. Click Update IP Address to open a utility that reports the known (“previous”) IP address for the product and allows you to change the IP address, if necessary.

Product software issues (OS X)

A print job was not sent to the product that you wanted

1. Open the print queue and restart the print job.
2. Another product with the same or similar name might have received your print job. Print a configuration page to check the product name. Verify that the name on the configuration page matches the product name in the Printers list.

You are using a generic printer driver when using a USB connection

If you connected the USB cable before you installed the software, you might be using a generic printer driver instead of the driver for this product.

1. Delete the generic printer driver.
2. Reinstall the software from the product CD. Do not connect the USB cable until the software installation program prompts you.
3. If multiple printers are installed, make sure that you have selected the correct printer in the **Format For** pop-up menu in the **Print** dialog box.

8 Service and support

- [Customer support](#)
- [HP limited warranty statement](#)

Customer support

If you need help from an HP technical support representative to solve a problem, contact [HP Customer Support](#).

Register your product	www.register.hp.com
Download software utilities, drivers, and electronic documentation	HP Customer Support
Get 24-hour Internet product support and troubleshooting and download drivers and software, and electronic information	HP Customer Support
Get support for products used with a Mac computer	HP Customer Support
Get telephone support, free during your warranty period, for your country/region	Country/region phone numbers are on the flyer that was in the box with your product or at HP Customer Support .
Have the product name, serial number, date of purchase, and problem description ready.	
Order additional HP service or maintenance agreements	www.hp.com/go/carepack

HP limited warranty statement

HP PRODUCT	DURATION OF LIMITED WARRANTY
HP PageWide Pro 452dn, 452dw	1 year

HP warrants to you, the end-user customer, that HP hardware and accessories will be free from defects in materials and workmanship after the date of purchase, for the period specified above. If HP receives notice of such defects during the warranty period, HP will, at its option, either repair or replace products which prove to be defective. Replacement products may be either new or equivalent in performance to new.

HP warrants to you that HP software will not fail to execute its programming instructions after the date of purchase, for the period specified above, due to defects in material and workmanship when properly installed and used. If HP receives notice of such defects during the warranty period, HP will replace software which does not execute its programming instructions due to such defects.

HP does not warrant that the operation of HP products will be uninterrupted or error free. If HP is unable, within a reasonable time, to repair or replace any product to a condition as warranted, you will be entitled to a refund of the purchase price upon prompt return of the product.

HP products may contain remanufactured parts equivalent to new in performance or may have been subject to incidental use.

Warranty does not apply to defects resulting from (a) improper or inadequate maintenance or calibration, (b) software, interfacing, parts or supplies not supplied by HP, (c) unauthorized modification or misuse, (d) operation outside of the published environmental specifications for the product, or (e) improper site preparation or maintenance.

HP's limited warranty is void in the event the printer is attached to an aftermarket apparatus or system that modifies the printer's functionality such as a continuous ink system.

TO THE EXTENT ALLOWED BY LOCAL LAW, THE ABOVE WARRANTIES ARE EXCLUSIVE AND NO OTHER WARRANTY OR CONDITION, WHETHER WRITTEN OR ORAL, IS EXPRESSED OR IMPLIED AND HP SPECIFICALLY DISCLAIMS ANY IMPLIED WARRANTIES OR CONDITIONS OF MERCHANTABILITY, SATISFACTORY QUALITY, AND FITNESS FOR A PARTICULAR PURPOSE. Some countries/regions, states or provinces do not allow limitations on the duration of an implied warranty, so the above limitation or exclusion might not apply to you. This warranty gives you specific legal rights and you might also have other rights that vary from country/region to country/region, state to state, or province to province.

HP's limited warranty is valid in any country/region or locality where HP has a support presence for this product and where HP has marketed this product. The level of warranty service you receive may vary according to local standards. HP will not alter form, fit or function of the product to make it operate in a country/region for which it was never intended to function for legal or regulatory reasons.

TO THE EXTENT ALLOWED BY LOCAL LAW, THE REMEDIES IN THIS WARRANTY STATEMENT ARE YOUR SOLE AND EXCLUSIVE REMEDIES. EXCEPT AS INDICATED ABOVE, IN NO EVENT WILL HP OR ITS SUPPLIERS BE LIABLE FOR LOSS OF DATA OR FOR DIRECT, SPECIAL, INCIDENTAL, CONSEQUENTIAL (INCLUDING LOST PROFIT OR DATA), OR OTHER DAMAGE, WHETHER BASED IN CONTRACT, TORT, OR OTHERWISE. Some countries/regions, states or provinces do not allow the exclusion or limitation of incidental or consequential damages, so the above limitation or exclusion may not apply to you.

THE WARRANTY TERMS CONTAINED IN THIS STATEMENT, EXCEPT TO THE EXTENT LAWFULLY PERMITTED, DO NOT EXCLUDE, RESTRICT OR MODIFY AND ARE IN ADDITION TO THE MANDATORY STATUTORY RIGHTS APPLICABLE TO THE SALE OF THIS PRODUCT TO YOU.

UK, Ireland, and Malta

The HP Limited Warranty is a commercial guarantee voluntarily provided by HP. The name and address of the HP entity responsible for the performance of the HP Limited Warranty in your country/region is as follows:

UK: HP Inc UK Limited, Cain Road, Amen Corner, Bracknell, Berkshire, RG12 1HN

Ireland: Hewlett-Packard Ireland Limited, Liffey Park Technology Campus, Barnhall Road, Leixlip, Co.Kildare

Malta: Hewlett-Packard Europe B.V., Amsterdam, Meyrin Branch, Route du Nant-d'Avril 150, 1217 Meyrin, Switzerland

United Kingdom: The HP Limited Warranty benefits apply in addition to any legal rights to a guarantee from seller of nonconformity of goods with the contract of sale. These rights expire six years from delivery of goods for products purchased in England or Wales and five years from delivery of goods for products purchased in Scotland. However various factors may impact your eligibility to receive these rights. For further information, please consult the following link: Consumer Legal Guarantee (www.hp.com/go/eu-legal) or you may visit the European Consumer Centers website (http://ec.europa.eu/consumers/solving_consumer_disputes/non-judicial_redress/ecc-net/index_en.htm). Consumers have the right to choose whether to claim service under the HP Limited Warranty or against the seller under the legal guarantee.

Ireland: The HP Limited Warranty benefits apply in addition to any statutory rights from seller in relation to nonconformity of goods with the contract of sale. However various factors may impact your eligibility to receive these rights. Consumer statutory rights are not limited or affected in any manner by HP Care Pack. For further information, please consult the following link: Consumer Legal Guarantee (www.hp.com/go/eu-legal) or you may visit the European Consumer Centers website (http://ec.europa.eu/consumers/solving_consumer_disputes/non-judicial_redress/ecc-net/index_en.htm). Consumers have the right to choose whether to claim service under the HP Limited Warranty or against the seller under the legal guarantee.

Malta: The HP Limited Warranty benefits apply in addition to any legal rights to a two-year guarantee from seller of nonconformity of goods with the contract of sale; however various factors may impact your eligibility to receive these rights. Consumer statutory rights are not limited or affected in any manner by the HP Limited Warranty. For further information, please consult the following link: Consumer Legal Guarantee (www.hp.com/go/eu-legal) or you may visit the European Consumer Centers website (http://ec.europa.eu/consumers/solving_consumer_disputes/non-judicial_redress/ecc-net/index_en.htm). Consumers have the right to choose whether to claim service under the HP Limited Warranty or against the seller under two-year legal guarantee.

Austria, Belgium, Germany, and Luxemburg

Die beschränkte HP Herstellergarantie ist eine von HP auf freiwilliger Basis angebotene kommerzielle Garantie. Der Name und die Adresse der HP Gesellschaft, die in Ihrem Land für die Gewährung der beschränkten HP Herstellergarantie verantwortlich ist, sind wie folgt:

Deutschland: HP Deutschland GmbH, Schickardstr. 32, D-71034 Böblingen

Österreich: HP Austria GmbH., Technologiestrasse 5, A-1120 Wien

Luxemburg: Hewlett-Packard Luxembourg S.C.A., 75, Parc d'Activités Capellen, Rue Pafebruc, L-8308 Capellen

Belgien: HP Belgium BVBA, Hermeslaan 1A, B-1831 Diegem

Die Rechte aus der beschränkten HP Herstellergarantie gelten zusätzlich zu den gesetzlichen Ansprüchen wegen Sachmängeln auf eine zweijährige Gewährleistung ab dem Lieferdatum. Ob Sie Anspruch auf diese Rechte haben, hängt von zahlreichen Faktoren ab. Die Rechte des Kunden sind in keiner Weise durch die

beschränkte HP Herstellergarantie eingeschränkt bzw. betroffen. Weitere Hinweise finden Sie auf der folgenden Website: Gewährleistungsansprüche für Verbraucher (www.hp.com/go/eu-legal) oder Sie können die Website des Europäischen Verbrauchersentrums (http://ec.europa.eu/consumers/solving_consumer_disputes/non-judicial_redress/ecc-net/index_en.htm) besuchen. Verbraucher haben das Recht zu wählen, ob sie eine Leistung von HP gemäß der beschränkten HP Herstellergarantie in Anspruch nehmen oder ob sie sich gemäß der gesetzlichen zweijährigen Haftung für Sachmängel (Gewährleistung) sich an den jeweiligen Verkäufer wenden.

Belgium, France, and Luxembourg

La garantie limitée HP est une garantie commerciale fournie volontairement par HP. Voici les coordonnées de l'entité HP responsable de l'exécution de la garantie limitée HP dans votre pays:

France: HP France SAS, société par actions simplifiée identifiée sous le numéro 448 694 133 RCS Evry, 1 Avenue du Canada, 91947, Les Ulis

G.D. Luxembourg: Hewlett-Packard Luxembourg S.C.A., 75, Parc d'Activités Capellen, Rue Pafebruc, L-8308 Capellen

Belgique: HP Belgium BVBA, Hermeslaan 1A, B-1831 Diegem

France: Les avantages de la garantie limitée HP s'appliquent en complément des droits dont vous disposez au titre des garanties légales applicables dont le bénéfice est soumis à des conditions spécifiques. Vos droits en tant que consommateur au titre de la garantie légale de conformité mentionnée aux articles L. 211-4 à L. 211-13 du Code de la Consommation et de celle relatives aux défauts de la chose vendue, dans les conditions prévues aux articles 1641 à 1648 et 2232 du Code de Commerce ne sont en aucune façon limités ou affectés par la garantie limitée HP. Pour de plus amples informations, veuillez consulter le lien suivant : Garanties légales accordées au consommateur (www.hp.com/go/eu-legal). Vous pouvez également consulter le site Web des Centres européens des consommateurs (http://ec.europa.eu/consumers/solving_consumer_disputes/non-judicial_redress/ecc-net/index_en.htm). Les consommateurs ont le droit de choisir d'exercer leurs droits au titre de la garantie limitée HP, ou auprès du vendeur au titre des garanties légales applicables mentionnées ci-dessus.

POUR RAPPEL:

Garantie Légale de Conformité:

« Le vendeur est tenu de livrer un bien conforme au contrat et répond des défauts de conformité existant lors de la délivrance.

Il répond également des défauts de conformité résultant de l'emballage, des instructions de montage ou de l'installation lorsque celle-ci a été mise à sa charge par le contrat ou a été réalisée sous sa responsabilité ».

Article L211-5 du Code de la Consommation:

« Pour être conforme au contrat, le bien doit:

1° Etre propre à l'usage habituellement attendu d'un bien semblable et, le cas échéant:

- correspondre à la description donnée par le vendeur et posséder les qualités que celui-ci a présentées à l'acheteur sous forme d'échantillon ou de modèle;

- présenter les qualités qu'un acheteur peut légitimement attendre eu égard aux déclarations publiques faites par le vendeur, par le producteur ou par son représentant, notamment dans la publicité ou l'étiquetage;

2° Ou présenter les caractéristiques définies d'un commun accord par les parties ou être propre à tout usage spécial recherché par l'acheteur, porté à la connaissance du vendeur et que ce dernier a accepté ».

Article L211-12 du Code de la Consommation:

« L'action résultant du défaut de conformité se prescrit par deux ans à compter de la délivrance du bien ».

Garantie des vices cachés

Article 1641 du Code Civil : *« Le vendeur est tenu de la garantie à raison des défauts cachés de la chose vendue qui la rendent impropre à l'usage auquel on la destine, ou qui diminuent tellement cet usage que l'acheteur ne l'aurait pas acquise, ou n'en aurait donné qu'un moindre prix, s'il les avait connus. »*

Article 1648 alinéa 1 du Code Civil:

« L'action résultant des vices rédhibitoires doit être intentée par l'acquéreur dans un délai de deux ans à compter de la découverte du vice. »

G.D. Luxembourg et Belgique: Les avantages de la garantie limitée HP s'appliquent en complément des droits dont vous disposez au titre de la garantie de non-conformité des biens avec le contrat de vente. Cependant, de nombreux facteurs peuvent avoir un impact sur le bénéfice de ces droits. Vos droits en tant que consommateur au titre de ces garanties ne sont en aucune façon limités ou affectés par la garantie limitée HP. Pour de plus amples informations, veuillez consulter le lien suivant : Garanties légales accordées au consommateur (www.hp.com/go/eu-legal) ou vous pouvez également consulter le site Web des Centres européens des consommateurs (http://ec.europa.eu/consumers/solving_consumer_disputes/non-judicial_redress/ecc-net/index_en.htm). Les consommateurs ont le droit de choisir de réclamer un service sous la garantie limitée HP ou auprès du vendeur au cours d'une garantie légale de deux ans.

Italy

La Garanzia limitata HP è una garanzia commerciale fornita volontariamente da HP. Di seguito sono indicati nome e indirizzo della società HP responsabile della fornitura dei servizi coperti dalla Garanzia limitata HP nel vostro Paese:

Italia: HP Italy S.r.l., Via G. Di Vittorio 9, 20063 Cernusco S/Naviglio

I vantaggi della Garanzia limitata HP vengono concessi ai consumatori in aggiunta ai diritti derivanti dalla garanzia di due anni fornita dal venditore in caso di non conformità dei beni rispetto al contratto di vendita. Tuttavia, diversi fattori possono avere un impatto sulla possibilità di beneficiare di tali diritti. I diritti spettanti ai consumatori in forza della garanzia legale non sono in alcun modo limitati, né modificati dalla Garanzia limitata HP. Per ulteriori informazioni, si prega di consultare il seguente link: Garanzia legale per i clienti (www.hp.com/go/eu-legal), oppure visitare il sito Web dei Centri europei per i consumatori (http://ec.europa.eu/consumers/solving_consumer_disputes/non-judicial_redress/ecc-net/index_en.htm). I consumatori hanno il diritto di scegliere se richiedere un servizio usufruendo della Garanzia limitata HP oppure rivolgendosi al venditore per far valere la garanzia legale di due anni.

Spain

Su Garantía limitada de HP es una garantía comercial voluntariamente proporcionada por HP. El nombre y dirección de las entidades HP que proporcionan la Garantía limitada de HP (garantía comercial adicional del fabricante) en su país es:

España: Hewlett-Packard Española S.L. Calle Vicente Aleixandre, 1 Parque Empresarial Madrid - Las Rozas, E-28232 Madrid

Los beneficios de la Garantía limitada de HP son adicionales a la garantía legal de 2 años a la que los consumidores tienen derecho a recibir del vendedor en virtud del contrato de compraventa; sin embargo, varios factores pueden afectar su derecho a recibir los beneficios bajo dicha garantía legal. A este respecto, la Garantía limitada de HP no limita o afecta en modo alguno los derechos legales del consumidor (www.hp.com/go/eu-legal). Para más información, consulte el siguiente enlace: Garantía legal del

consumidor o puede visitar el sitio web de los Centros europeos de los consumidores (http://ec.europa.eu/consumers/solving_consumer_disputes/non-judicial_redress/ecc-net/index_en.htm). Los clientes tienen derecho a elegir si reclaman un servicio acogiéndose a la Garantía limitada de HP o al vendedor de conformidad con la garantía legal de dos años.

Denmark

Den begrænsede HP-garanti er en garanti, der ydes frivilligt af HP. Navn og adresse på det HP-selskab, der er ansvarligt for HP's begrænsede garanti i dit land, er som følger:

Danmark: HP Inc Danmark ApS, Engholm Parkvej 8, 3450, Allerød

Den begrænsede HP-garanti gælder i tillæg til eventuelle juridiske rettigheder, for en toårig garanti fra sælgeren af varer, der ikke er i overensstemmelse med salgsaftalen, men forskellige faktorer kan dog påvirke din ret til at opnå disse rettigheder. Forbrugerens lovbestemte rettigheder begrænses eller påvirkes ikke på nogen måde af den begrænsede HP-garanti. Se nedenstående link for at få yderligere oplysninger: Forbrugerens juridiske garanti (www.hp.com/go/eu-legal) eller du kan besøge De Europæiske Forbrugercentres websted (http://ec.europa.eu/consumers/solving_consumer_disputes/non-judicial_redress/ecc-net/index_en.htm). Forbrugere har ret til at vælge, om de vil gøre krav på service i henhold til HP's begrænsede garanti eller hos sælger i henhold til en toårig juridisk garanti.

Norway

HPs garanti er en begrenset og kommersiell garanti som HP selv har valgt å tilby. Følgende lokale selskap innestår for garantien:

Norge: HP Norge AS, Rolfbuktveien 4b, 1364 Fornebu

HPs garanti kommer i tillegg til det mangelsansvar HP har i henhold til norsk forbrukerkjøpslovgivning, hvor reklamasjonsperioden kan være to eller fem år, avhengig av hvor lenge salgsgjenstanden var ment å vare. Ulike faktorer kan imidlertid ha betydning for om du kvalifiserer til å kreve avhjelp iht slikt mangelsansvar. Forbrukerens lovmessige rettigheter begrenses ikke av HPs garanti. Hvis du vil ha mer informasjon, kan du klikke på følgende kobling: Juridisk garanti for forbruker (www.hp.com/go/eu-legal) eller du kan besøke nettstedet til de europeiske forbrukersentrene (http://ec.europa.eu/consumers/solving_consumer_disputes/non-judicial_redress/ecc-net/index_en.htm). Forbrukere har retten til å velge å kreve service under HPs garanti eller iht selgerens lovpålagte mangelsansvar.

Sweden

HP:s begränsade garanti är en kommersiell garanti som tillhandahålls frivilligt av HP. Namn och adress till det HP-företag som ansvarar för HP:s begränsade garanti i ditt land är som följer:

Sverige: HP PPS Sverige AB, SE-169 73 Stockholm

Fördelarna som ingår i HP:s begränsade garanti gäller utöver de lagstadgade rättigheterna till tre års garanti från säljaren angående varans bristande överensstämmelse gentemot köpeavtalet, men olika faktorer kan påverka din rätt att utnyttja dessa rättigheter. Konsumentens lagstadgade rättigheter varken begränsas eller påverkas på något sätt av HP:s begränsade garanti. Mer information får du om du följer denna länk: Lagstadgad garanti för konsumenter (www.hp.com/go/eu-legal) eller så kan du gå till European Consumer Centers webbplats (http://ec.europa.eu/consumers/solving_consumer_disputes/non-judicial_redress/ecc-net/index_en.htm). Konsumenter har rätt att välja om de vill ställa krav enligt HP:s begränsade garanti eller på säljaren enligt den lagstadgade treåriga garantin.

Portugal

A Garantia Limitada HP é uma garantia comercial fornecida voluntariamente pela HP. O nome e a morada da entidade HP responsável pela prestação da Garantia Limitada HP no seu país são os seguintes:

Portugal: HPCP – Computing and Printing Portugal, Unipessoal, Lda., Edifício D. Sancho I, Quinta da Fonte, Porto Salvo, Lisboa, Oeiras, 2740 244

As vantagens da Garantia Limitada HP aplicam-se cumulativamente com quaisquer direitos decorrentes da legislação aplicável à garantia de dois anos do vendedor, relativa a defeitos do produto e constante do contrato de venda. Existem, contudo, vários fatores que poderão afetar a sua elegibilidade para beneficiar de tais direitos. Os direitos legalmente atribuídos aos consumidores não são limitados ou afetados de forma alguma pela Garantia Limitada HP. Para mais informações, consulte a ligação seguinte: Garantia legal do consumidor (www.hp.com/go/eu-legal) ou visite o Web site da Rede dos Centros Europeus do Consumidor (http://ec.europa.eu/consumers/solving_consumer_disputes/non-judicial_redress/ecc-net/index_en.htm). Os consumidores têm o direito de escolher se pretendem reclamar assistência ao abrigo da Garantia Limitada HP ou contra o vendedor ao abrigo de uma garantia jurídica de dois anos.

Greece and Cyprus

Η Περιορισμένη εγγύηση HP είναι μια εμπορική εγγύηση η οποία παρέχεται εθελοντικά από την HP. Η επωνυμία και η διεύθυνση του νομικού προσώπου HP που παρέχει την Περιορισμένη εγγύηση HP στη χώρα σας είναι η εξής:

Ελλάδα /Κύπρος: HP Printing and Personal Systems Hellas EPE, Tzavella 1-3, 15232 Chalandri, Attiki

Ελλάδα /Κύπρος: HP Συστήματα Εκτύπωσης και Προσωπικών Υπολογιστών Ελλάς Εταιρεία Περιορισμένης Ευθύνης, Tzavella 1-3, 15232 Chalandri, Attiki

Τα προνόμια της Περιορισμένης εγγύησης HP ισχύουν επιπλέον των νόμιμων δικαιωμάτων για διετή εγγύηση έναντι του Πωλητή για τη μη συμμόρφωση των προϊόντων με τις συνομολογημένες συμβατικά ιδιότητες, ωστόσο η άσκηση των δικαιωμάτων σας αυτών μπορεί να εξαρτάται από διάφορους παράγοντες. Τα νόμιμα δικαιώματα των καταναλωτών δεν περιορίζονται ούτε επηρεάζονται καθ' οιονδήποτε τρόπο από την Περιορισμένη εγγύηση HP. Για περισσότερες πληροφορίες, συμβουλευτείτε την ακόλουθη τοποθεσία web: Νόμιμη εγγύηση καταναλωτή (www.hp.com/go/eu-legal) ή μπορείτε να επισκεφτείτε την τοποθεσία web των Ευρωπαϊκών Κέντρων Καταναλωτή (http://ec.europa.eu/consumers/solving_consumer_disputes/non-judicial_redress/ecc-net/index_en.htm). Οι καταναλωτές έχουν το δικαίωμα να επιλέξουν αν θα αξιώσουν την υπηρεσία στα πλαίσια της Περιορισμένης εγγύησης HP ή από τον πωλητή στα πλαίσια της νόμιμης εγγύησης δύο ετών.

Hungary

A HP korlátozott jótállás egy olyan kereskedelmi jótállás, amelyet a HP a saját elhatározásából biztosít. Az egyes országokban a HP mint gyártó által vállalt korlátozott jótállást biztosító HP vállalatok neve és címe:

Magyarország: HP Inc Magyarország Kft., H-1117 Budapest, Alíz utca 1.

A HP korlátozott jótállásban biztosított jogok azokon a jogokon felül illetik meg Önt, amelyek a termékeknek az adásvételi szerződés szerinti minőségére vonatkozó kétéves, jogszabályban foglalt eladói szavatosságból, továbbá ha az Ön által vásárolt termék alkalmazandó, a jogszabályban foglalt kötelező eladói jótállásból erednek, azonban számos körülmény hatással lehet arra, hogy ezek a jogok Önt megilletik-e. További információért kérjük, keresse fel a következő webhelyet: Jogi Tájékoztató Fogyasztóknak (www.hp.com/go/eu-legal) vagy látogassa meg az Európai Fogyasztói Központok webhelyét (http://ec.europa.eu/consumers/solving_consumer_disputes/non-judicial_redress/ecc-net/index_en.htm). A fogyasztóknak jogában áll, hogy megválasszák, hogy a jótállással kapcsolatos igényüket a HP korlátozott

jótállás alapján vagy a kétéves, jogszabályban foglalt eladói szavatosság, illetve, ha alkalmazandó, a jogszabályban foglalt kötelező eladói jótállás alapján érvényesítik.

Czech Republic

Omezená záruka HP je obchodní zárukou dobrovolně poskytovanou společností HP. Názvy a adresy společností skupiny HP, které odpovídají za plnění omezené záruky HP ve vaší zemi, jsou následující:

Česká republika: HP Inc Czech Republic s. r. o., Za Brumlovkou 5/1559, 140 00 Praha 4

Výhody, poskytované omezenou zárukou HP, se uplatňují jako doplněk k jakýmkoli právním nárokům na dvouletou záruku poskytnutou prodejcem v případě nesouladu zboží s kupní smlouvou. Váš nárok na uznání těchto práv však může záviset na mnohých faktorech. Omezená záruka HP žádným způsobem neomezuje ani neovlivňuje zákonná práva zákazníka. Další informace získáte kliknutím na následující odkaz: Zákonná záruka spotřebitele (www.hp.com/go/eu-legal) případně můžete navštívit webové stránky Evropského spotřebitelského centra (http://ec.europa.eu/consumers/solving_consumer_disputes/non-judicial_redress/ecc-net/index_en.htm). Spotřebitelé mají právo se rozhodnout, zda chtějí službu reklamovat v rámci omezené záruky HP nebo v rámci zákonem stanovené dvouleté záruky u prodejce.

Slovakia

Obmedzená záruka HP je obchodná záruka, ktorú spoločnosť HP poskytuje dobrovoľne. Meno a adresa subjektu HP, ktorý zabezpečuje plnenie vyplývajúce z Obmedzenej záruky HP vo vašej krajine:

Slovenská republika: HP Inc Slovakia, s.r.o., Galvaniho 7, 821 04 Bratislava

Výhody Obmedzenej záruky HP sa uplatnia vedľa prípadných zákazníkových zákonných nárokov voči predávajúcemu z váš strany, ktoré spočívajú v nesúlade vlastností tovaru s jeho popisom podľa predmetnej zmluvy. Možnosť uplatnenia takých prípadných nárokov však môže závisieť od rôznych faktorov. Služby Obmedzenej záruky HP žiadnym spôsobom neobmedzujú ani neovplyvňujú zákonné práva zákazníka, ktorý je spotrebiteľom. Ďalšie informácie nájdete na nasledujúcom prepojení: Zákonná záruka spotrebiteľa (www.hp.com/go/eu-legal), prípadne môžete navštíviť webovú lokalitu európskych zákazníckych stredísk (http://ec.europa.eu/consumers/solving_consumer_disputes/non-judicial_redress/ecc-net/index_en.htm). Spotrebiteľia majú právo zvoliť si, či chcú uplatniť servis v rámci Obmedzenej záruky HP alebo počas zákonnej dvojročnej záručnej lehoty u predajcu.

Poland

Ograniczona gwarancja HP to komercyjna gwarancja udzielona dobrowolnie przez HP. Nazwa i adres podmiotu HP odpowiedzialnego za realizację Ograniczonej gwarancji HP w Polsce:

Polska: HP Inc Polska sp. z o.o., Szturmowa 2a, 02-678 Warszawa, wpisana do rejestru przedsiębiorców prowadzonego przez Sąd Rejonowy dla m.st. Warszawy w Warszawie, XIII Wydział Gospodarczy Krajowego Rejestru Sądowego, pod numerem KRS 0000546115, NIP 5213690563, REGON 360916326, GIOŚ E0020757WZBW, kapitał zakładowy 480.000 PLN.

Świadczenia wynikające z Ograniczonej gwarancji HP stanowią dodatek do praw przysługujących nabywcy w związku z dwuletnią odpowiedzialnością sprzedawcy z tytułu niezgodności towaru z umową (rękojmia). Niemniej, na możliwość korzystania z tych praw mają wpływ różne czynniki. Ograniczona gwarancja HP w żaden sposób nie ogranicza praw konsumenta ani na nie nie wpływa. Więcej informacji można znaleźć pod następującym łączem: Gwarancja prawna konsumenta (www.hp.com/go/eu-legal), można także odwiedzić stronę internetową Europejskiego Centrum Konsumentckiego (http://ec.europa.eu/consumers/solving_consumer_disputes/non-judicial_redress/ecc-net/index_en.htm). Konsumentci mają prawo wyboru co do możliwości skorzystania albo z usług gwarancyjnych przysługujących w ramach Ograniczonej gwarancji HP albo z uprawnień wynikających z dwuletniej rękojmi w stosunku do sprzedawcy.

Bulgaria

Ограничената гаранция на HP представлява търговска гаранция, доброволно предоставяна от HP. Името и адресът на дружеството на HP за вашата страна, отговорно за предоставянето на гаранционната поддръжка в рамките на Ограничената гаранция на HP, са както следва:

HP Inc Bulgaria EOOD (Ейч Пи Инк България EOOD), гр. София 1766, район р-н Младост, бул. Околовръстен Път No 258, Бизнес Център Камбаните

Предимствата на Ограничената гаранция на HP се прилагат в допълнение към всички законови права за двугодишна гаранция от продавача при несъответствие на стоката с договора за продажба. Въпреки това, различни фактори могат да окажат влияние върху условията за получаване на тези права. Законите права на потребителите не са ограничени или засегнати по никакъв начин от Ограничената гаранция на HP. За допълнителна информация, моля вижте Правната гаранция на потребителя (www.hp.com/go/eu-legal) или посетете уебсайта на Европейския потребителски център (http://ec.europa.eu/consumers/solving_consumer_disputes/non-judicial_redress/ecc-net/index_en.htm). Потребителите имат правото да избират дали да претендират за извършване на услуга в рамките на Ограничената гаранция на HP или да потърсят такава от търговеца в рамките на двугодишната правна гаранция.

Romania

Garanția limitată HP este o garanție comercială furnizată în mod voluntar de către HP. Numele și adresa entității HP răspunzătoare de punerea în aplicare a Garanției limitate HP în țara dumneavoastră sunt următoarele:

România: HP Inc Romania SRL, 5 Fabrica de Glucoza Str., Building F, Ground Floor & Floor 8, 2nd District, București

Beneficiile Garanției limitate HP se aplică suplimentar față de orice drepturi privind гаранцията de doi ani oferită de vânзător pentru neconformitatea bunurilor cu contractul de vânзаре; cu toate acestea, diversi фактори pot avea impact asupra eligibilității dvs. de a beneficia de aceste drepturi. Drepturile legale ale consumatorului nu sunt limitate sau afectate în vreun fel de Гаранцията limitată HP. Pentru информацияи suplimentare consultați următorul link: гаранцията acordată consumatorului prin lege (www.hp.com/go/eu-legal) sau puteți accesa site-ul Centrul European al Consumatorilor (http://ec.europa.eu/consumers/solving_consumer_disputes/non-judicial_redress/ecc-net/index_en.htm). Consumatorii au dreptul să aleagă dacă să pretendă despăгубири în cadrul Гаранției limitate HP sau de la vânзător, în cadrul гаранției legale de doi ani.

Belgium and the Netherlands

De Beperkte Garantie van HP is een commerciële garantie vrijwillig verstrekt door HP. De naam en het adres van de HP-entiteit die verantwoordelijk is voor het uitvoeren van de Beperkte Garantie van HP in uw land is als volgt:

Nederland: HP Nederland B.V., Startbaan 16, 1187 XR Amstelveen

België: HP Belgium BVBA, Hermeslaan 1A, B-1831 Diegem

De voordelen van de Beperkte Garantie van HP vormen een aanvulling op de wettelijke garantie voor consumenten gedurende twee jaren na de levering te verlenen door de verkoper bij een gebrek aan conformiteit van de goederen met de relevante verkoopovereenkomst. Niettemin kunnen diverse factoren een impact hebben op uw eventuele aanspraak op deze wettelijke rechten. De wettelijke rechten van de consument worden op geen enkele wijze beperkt of beïnvloed door de Beperkte Garantie van HP. Raadpleeg voor meer informatie de volgende webpagina: Wettelijke garantie van de consument (www.hp.com/go/eu-legal) of u kan de website van het Europees Consumenten Centrum bezoeken (http://ec.europa.eu/consumers/solving_consumer_disputes/non-judicial_redress/ecc-net/index_en.htm). Consumenten hebben

het recht om te kiezen tussen enerzijds de Beperkte Garantie van HP of anderzijds het aanspreken van de verkoper in toepassing van de wettelijke garantie.

Finland

HP:n rajoitettu takuu on HP:n vapaaehtoisesti antama kaupallinen takuu. HP:n myöntämästä takuusta maassanne vastaavan HP:n edustajan yhteystiedot ovat:

Suomi: HP Finland Oy, Piispankalliontie, FIN - 02200 Espoo

HP:n takuun edut ovat voimassa mahdollisten kuluttajansuojalakiin perustuvien oikeuksien lisäksi sen varalta, että tuote ei vastaa myyntisopimusta. Saat lisätietoja seuraavasta linkistä: Kuluttajansuoja (www.hp.com/go/eu-legal) tai voit käydä Euroopan kuluttajakeskuksen sivustolla (http://ec.europa.eu/consumers/solving_consumer_disputes/non-judicial_redress/ecc-net/index_en.htm). Kuluttajilla on oikeus vaatia virheen korjausta HP:n takuun ja kuluttajansuojan perusteella HP:lta tai myyjältä.

Slovenia

Omejena garancija HP je prostovoljna trgovska garancija, ki jo zagotavlja podjetje HP. Ime in naslov poslovne enote HP, ki je odgovorna za omejeno garancijo HP v vaši državi, sta naslednja:

Slovenija: Hewlett-Packard Europe B.V., Amsterdam, Meyrin Branch, Route du Nant-d'Avril 150, 1217 Meyrin, Switzerland

Ugodnosti omejene garancije HP veljajo poleg zakonskih pravic, ki ob sklenitvi kupoprodajne pogodbe izhajajo iz dveletne garancije prodajalca v primeru neskladnosti blaga, vendar lahko na izpolnjevanje pogojev za uveljavitev pravic vplivajo različni dejavniki. Omejena garancija HP nikakor ne omejuje strankinih z zakonom predpisanih pravic in ne vpliva nanje. Za dodatne informacije glejte naslednjo povezavo: Strankino pravno jamstvo (www.hp.com/go/eu-legal); ali pa obiščite spletno mesto evropskih središč za potrošnike (http://ec.europa.eu/consumers/solving_consumer_disputes/non-judicial_redress/ecc-net/index_en.htm). Potrošniki imajo pravico izbrati, ali bodo uveljavljali pravice do storitev v skladu z omejeno garancijo HP ali proti prodajalcu v skladu z dvoletno zakonsko garancijo.

Croatia

HP ograničeno jamstvo komercijalno je dobrovoljno jamstvo koje pruža HP. Ime i adresa HP subjekta odgovornog za HP ograničeno jamstvo u vašoj državi:

Hrvatska: HP Computing and Printing d.o.o. za računalne i srodne aktivnosti, Radnička cesta 41, 10000 Zagreb

Pogodnosti HP ograničenog jamstva vrijede zajedno uz sva zakonska prava na dvogodišnje jamstvo kod bilo kojeg prodavača s obzirom na nepodudaranje robe s ugovorom o kupnji. Međutim, razni faktori mogu utjecati na vašu mogućnost ostvarivanja tih prava. HP ograničeno jamstvo ni na koji način ne utječe niti ne ograničava zakonska prava potrošača. Dodatne informacije potražite na ovoj adresi: Zakonsko jamstvo za potrošače (www.hp.com/go/eu-legal) ili možete posjetiti web-mjesto Evropskih potrošačkih centara (http://ec.europa.eu/consumers/solving_consumer_disputes/non-judicial_redress/ecc-net/index_en.htm). Potrošači imaju pravo odabrati žele li ostvariti svoja potraživanja u sklopu HP ograničenog jamstva ili pravnog jamstva prodavača u trajanju ispod dvije godine.

Latvia

HP ierobežotā garantija ir komercgarantija, kuru brīvprātīgi nodrošina HP. HP uzņēmums, kas sniedz HP ierobežotās garantijas servisa nodrošinājumu jūsu valstī:

Latvija: HP Finland Oy, PO Box 515, 02201 Espoo, Finland

HP ierobežotās garantijas priekšrocības tiek piedāvātas papildus jebkurām likumīgajām tiesībām uz pārdevēja un/vai ražotāju nodrošinātu divu gadu garantiju gadījumā, ja preces neatbilst pirkuma līgumam, tomēr šo tiesību saņemšanu var ietekmēt vairāki faktori. HP ierobežotā garantija nekādā veidā neierobežo un neietekmē patērētāju likumīgās tiesības. Lai iegūtu plašāku informāciju, izmantojiet šo saiti: Patērētāju likumīgā garantija (www.hp.com/go/eu-legal) vai arī Eiropas Patērētāju tiesību aizsardzības centra tīmekļa vietni (http://ec.europa.eu/consumers/solving_consumer_disputes/non-judicial_redress/ecc-net/index_en.htm). Patērētājiem ir tiesības izvēlēties, vai pieprasīt servisa nodrošinājumu saskaņā ar HP ierobežoto garantiju, vai arī pārdevēja sniegto divu gadu garantiju.

Lithuania

HP ribotoji garantija yra HP savanoriškai teikiama komercinė garantija. Toliau pateikiami HP bendrovių, teikiančių HP garantiją (gamintojo garantiją) jūsų šalyje, pavadinimai ir adresai:

Lietuva: HP Finland Oy, PO Box 515, 02201 Espoo, Finland

HP ribotoji garantija papildomai taikoma kartu su bet kokiomis kitomis įstatymais nustatytais teisėmis į pardavėjo suteikiamą dviejų metų laikotarpio garantiją dėl prekių atitikties pardavimo sutarčiai, tačiau tai, ar jums ši teisė bus suteikiama, gali priklausyti nuo įvairių aplinkybių. HP ribotoji garantija niekaip neapriboja ir neįtakoja įstatymais nustatytų vartotojo teisių. Daugiau informacijos rasite paspaudę šią nuorodą: Teisinė vartotojo garantija (www.hp.com/go/eu-legal) arba apsilankę Europos vartotojų centro internetinėje svetainėje (http://ec.europa.eu/consumers/solving_consumer_disputes/non-judicial_redress/ecc-net/index_en.htm). Vartotojai turi teisę prašyti atlikti techninį aptarnavimą pagal HP ribotąją garantiją arba pardavėjo teikiamą dviejų metų įstatymais nustatytą garantiją.

Estonia

HP piiratud garantii on HP poolt vabatahtlikult pakutav kaubanduslik garantii. HP piiratud garantii eest vastutab HP üksus aadressil:

Eesti: HP Finland Oy, PO Box 515, 02201 Espoo, Finland

HP piiratud garantii rakendub lisaks seaduses ettenähtud müüjapoolsele kaheaastasele garantiile, juhul kui toode ei vasta müügilepingu tingimustele. Siiski võib esineda asjaolusid, mille puhul teie jaoks need õigused ei pruugi kehtida. HP piiratud garantii ei piira ega mõjuta mingil moel tarbija seadusjärgseid õigusi. Lisateavet leiate järgmiselt lingilt: tarbija õiguslik garantii (www.hp.com/go/eu-legal) või võite külastada Euroopa tarbijakeskuste veebisaiti (http://ec.europa.eu/consumers/solving_consumer_disputes/non-judicial_redress/ecc-net/index_en.htm). Tarbijal on õigus valida, kas ta soovib kasutada HP piiratud garantiid või seadusega ette nähtud müüjapoolset kaheaastast garantiid.

Russia

Срок службы принтера для России

Срок службы данного принтера HP составляет пять лет в нормальных условиях эксплуатации. Срок службы отсчитывается с момента ввода принтера в эксплуатацию. В конце срока службы HP рекомендует посетить веб-сайт нашей службы поддержки по адресу <http://www.hp.com/support> и/или связаться с авторизованным поставщиком услуг HP для получения рекомендаций в отношении дальнейшего безопасного использования принтера.

A Technical information

- [Product specifications](#)
- [Environmental product stewardship program](#)
- [Regulatory information](#)

Product specifications

- [Print specifications](#)
- [Physical specifications](#)
- [Power consumption and electrical specifications](#)
- [Acoustic emission specifications](#)
- [Environmental specifications](#)

Print specifications

For a list of supported print resolutions, visit the printer support website at [HP Customer Support](#).

Physical specifications

Product	Product dimensions (width x depth x height)	Operation dimensions (width x depth x height)	Weight
HP PageWide Pro 452dn/dw series	530 x 401 x 380 mm (20.87 x 15.79 x 14.96 inches)	806 x 681 x 380 mm (31.73 x 26.81 x 14.96 inches)	16.4 kg (35.1 lb)

Power consumption and electrical specifications

 **CAUTION:** Power requirements are based on the country/region where the product is sold. Do not convert operating voltages. This will damage the product and any such damage is not covered under the HP limited warranty and service agreements.

Acoustic emission specifications

Operation	LwAd-mono (B)	LwAd-color (B)
Print	6.9	6.8

 **NOTE:** HP recommends that the printer be located in a room in which no employee has a regular workstation.

Environmental specifications

	Operating	Transporting
Temperature	15° to 30° C (59° to 86° F)	-40° to 60° C (-40° to 140° F)
Relative humidity	20 to 80%	90% or less (non-condensing)

	Operating	Transporting
Altitude	0 to 3048 m (0 to 10,000 ft)	
Tilt	IMPORTANT: Use caution when moving the product after you install the cartridges. Tilting the product at an angle greater than 3 degrees can result in ink leakage.	



NOTE: Values are subject to change.

Environmental product stewardship program

- [Protecting the environment](#)
- [Ozone production](#)
- [Power consumption](#)
- [European Union Commission Regulation 1275/2008](#)
- [Paper](#)
- [HP PageWide printing supplies](#)
- [Plastics](#)
- [Electronic hardware recycling](#)
- [Material restrictions](#)
 - [General battery information](#)
 - [Battery disposal in Taiwan](#)
 - [California Perchlorate Material Notice](#)
 - [EU Battery Directive](#)
 - [Battery notice for Brazil](#)
- [Chemical substances](#)
- [EPEAT](#)
- [Disposal of waste equipment by users](#)
- [Toxic and hazardous substance table \(China\)](#)
- [Restriction on hazardous substances statement \(Turkey\)](#)
- [Restriction on hazardous substances statement \(Ukraine\)](#)
- [Restriction of hazardous substance statement \(India\)](#)
- [China energy label for printer, fax, and copier](#)
- [China SEPA Eco Label user information](#)

Protecting the environment

HP is committed to providing quality products in an environmentally sound manner. This product has been designed with several attributes to minimize impacts on our environment.

Visit www.hp.com/go/environment or www.hp.com/hpinfo/globalcitizenship/environment to obtain more information about HP and the environment, including environmental profile sheets for these products, Material Data Safety Sheets, and HP return and recycling programs.

Ozone production

This product generates no appreciable ozone gas (O₃).

Power consumption

HP printing and imaging equipment marked with the ENERGY STAR® logo is certified by the U.S. Environmental Protection Agency. The following mark will appear on ENERGY STAR certified imaging products:



Additional ENERGY STAR certified imaging product model information is listed at: www.hp.com/go/energystar

European Union Commission Regulation 1275/2008

For product power data, including the power consumption of the product in networked standby if all wired network ports are connected and all wireless network ports are activated, please refer to section P14 'Additional Information' of the product IT ECO Declaration at www.hp.com/hpinfo/globalcitizenship/environment/productdata/itecodesktop-pc.html.

Paper

This product is capable of using recycled paper and lightweight paper (EcoFFICIENT™) when the paper meets the guidelines outlined in the product's Print Media Guide. This product is suitable for the use of recycled paper and lightweight paper (EcoFFICIENT™) according to EN12281:2002.

HP PageWide printing supplies

Original HP Supplies were designed with the environment in mind. HP makes it easy to conserve resources and paper when printing. And when you are done, we make it easy and free to recycle. Program availability varies. For more information, visit www.hp.com/recycle. To participate in HP Planet Partners return and recycling program, visit www.hp.com/recycle. Select your country/region for information on how to return your HP PageWide printing supplies.



NOTE: Visit the [HP sustainability](http://www.hp.com/sustainability) website for complete recycling information and to order postage-paid labels, envelopes, or boxes, for recycling.

Plastics

Plastic parts over 25 grams are marked according to international standards that enhance the ability to identify plastics for recycling purposes at the end of the product's life.

Electronic hardware recycling

HP encourages customers to recycle used electronic hardware. For more information about recycling programs, visit the [HP sustainability](#) website.

Material restrictions

- [General battery information](#)
- [Battery disposal in Taiwan](#)
- [California Perchlorate Material Notice](#)
- [EU Battery Directive](#)
- [Battery notice for Brazil](#)

General battery information

This HP product does not contain intentionally added mercury.

This HP product contains a battery that might require special handling at end-of-life. The batteries contained in or supplied by HP for this product include the following.

HP PageWide Pro 452 series	
Type	Lithium Manganese Dioxide
Weight	3.0 g
Location	On main board
User-removable	No

Battery disposal in Taiwan



廢電池請回收

Please recycle waste batteries.

California Perchlorate Material Notice

California Perchlorate Material Notice

Perchlorate material - special handling may apply. See:
<http://www.dtsc.ca.gov/hazardouswaste/perchlorate/>

This product's real-time clock battery or coin cell battery may contain perchlorate and may require special handling when recycled or disposed of in California.

EU Battery Directive

This product contains a battery that is used to maintain data integrity of real time clock or product settings and is designed to last the life of the product. Any attempt to service or replace this battery should be performed by a qualified service technician.



Battery notice for Brazil

A bateria deste equipamento não foi projetada para ser removida pelo cliente.

Chemical substances

HP is committed to providing our customers with information about the chemical substances in our products as needed to comply with legal requirements such as REACH (Regulation EC No 1907/2006 of the European Parliament and the Council). A chemical information report for this product can be found at <http://www.hp.com/go/reach>.

EPEAT

Most HP products are designed to meet EPEAT. EPEAT is a comprehensive environmental rating that helps identify greener electronics equipment. For more information on EPEAT go to www.epeat.net. For information on HP's EPEAT registered products go to www.hp.com/hpinfo/globalcitizenship/environment/pdf/epeat_printers.pdf.

Disposal of waste equipment by users



This symbol means do not dispose of your product with your other household waste. Instead, you should protect human health and the environment by handing over your waste equipment to a designated collection point for the recycling of waste electrical and electronic equipment. For more information, go to <http://www.hp.com/recycle>

Toxic and hazardous substance table (China)

产品中有害物质或元素的名称及含量
根据中国《电子信息产品污染控制管理办法》



零件描述	有害物质					
	铅	汞	镉	六价铬	多溴联苯	多溴联苯醚
外壳和托盘*	0	0	0	0	0	0
电线*	0	0	0	0	0	0
印刷电路板*	X	0	0	0	0	0
打印系统*	X	0	0	0	0	0
显示器*	X	0	0	0	0	0
喷墨打印机墨盒*	0	0	0	0	0	0
驱动光盘*	X	0	0	0	0	0
扫描仪*	X	X	0	0	0	0
网络配件*	X	0	0	0	0	0
电池板*	X	0	0	0	0	0
自动双面打印系统*	0	0	0	0	0	0
外部电源*	X	0	0	0	0	0

本表格依据 SJ/T 11364 的规定编制。
 0: 表示该有害物质在该部件所有均质材料中的含量均在 GB/T 26572 规定的限量要求以下。
 X: 表示该有害物质至少在该部件的某一均质材料中的含量超出 GB/T 26572 规定的限量要求。
 此表中所有名称中含“X”的部件均符合欧盟 RoHS 立法。
 注: 环保使用期限的参考标识取决于产品正常工作的温度和湿度等条件

Restriction on hazardous substances statement (Turkey)

Türkiye Cumhuriyeti: EEE Yönetmeliğine Uygundur

Restriction on hazardous substances statement (Ukraine)

Обладнання відповідає вимогам Технічного регламенту щодо обмеження використання деяких небезпечних речовин в електричному та електронному обладнанні, затвердженого постановою Кабінету Міністрів України від 3 грудня 2008 № 1057

Restriction of hazardous substance statement (India)

Restriction of hazardous substances (India)

This product complies with the "India E-waste (Management and Handling) Rule 2011" and prohibits use of lead, mercury, hexavalent chromium, polybrominated biphenyls or polybrominated diphenyl ethers in concentrations exceeding 0.1 weight % and 0.01 weight % for cadmium, except for the exemptions set in Schedule 2 of the Rule.

复印机、打印机和传真机能源效率标识 实施规则

依据“复印机、打印机和传真机能源效率标识实施规则”，本打印机具有中国能效标签。根据“复印机、打印机和传真机能效限定值及能效等级”（“GB21521”）决定并计算得出该标签上所示的能效等级和 TEC (典型能耗) 值。

1. 能效等级

能效等级分为三个等级，等级 1 级能效最高。根据产品类型和打印速度标准决定能效限定值。

2. 能效信息

2.1 LaserJet 打印机和高性能喷墨打印机

- 典型能耗

典型能耗是正常运行 GB21521 测试方法中指定的时间后的耗电量。此数据表示为每周千瓦时 (kWh)。

标签上所示的能效数字按涵盖根据“复印机、打印机和传真机能源效率标识实施规则”选择的登记装置中所有配置的代表性配置测定而得。因此，本特定产品型号的实际能耗可能与标签上所示的数据不同。

有关规范的详情信息，请参阅 GB21521 标准的当前版本。

China SEPA Eco Label user information

中国环境标识认证产品用户说明

噪声大于63.0Db(A)的办公设备不宜放置于办公室内，请在独立的隔离区域使用。

如需长时间使用本产品或打印大量文件，请确保在通风良好的房间内使用。

如您需要确认本产品处于零能耗状态，请按下电源关闭按钮，并将插头从电源插座断开。

您可以使用再生纸，以减少资源耗费。

Regulatory information

- [Regulatory notices](#)
- [VCCI statement \(Japan\)](#)
- [Power cord instructions](#)
- [Power cord statement \(Japan\)](#)
- [EMC statement \(Korea\)](#)
- [Visual display workplaces statement for Germany](#)
- [European Union Regulatory Notice](#)
- [Additional statements for wireless products](#)

Regulatory notices

Regulatory model identification number

For regulatory identification purposes, your product is assigned a Regulatory Model Number. This regulatory number should not be confused with the marketing name or product numbers.

Product model number	Regulatory Model Number
PageWide Pro 452dn	VCVRA-1501-00
PageWide Pro 452dw	VCVRA-1501-01
PageWide Pro 452dw	VCVRA-1501-02

FCC statement

This equipment has been tested and found to comply with the limits for a Class B digital device, pursuant to Part 15 of the FCC Rules. These limits are designed to provide reasonable protection against harmful interference in a residential installation. This equipment generates, uses and can radiate radio frequency energy and, if not installed and used in accordance with the instructions, may cause harmful interference to radio communications. However, there is no guarantee that interference will not occur in a particular installation. If this equipment does cause harmful interference to radio or television reception, which can be determined by turning the equipment off and on, the user is encouraged to try to correct the interference by one or more of the following measures:

- Reorient or relocate the receiving antenna.
- Increase the separation between the equipment and receiver.
- Connect the equipment into an outlet on a circuit different from that to which the receiver is connected.
- Consult the dealer or an experienced radio/TV technician for help.



NOTE: Any changes or modifications made to this device that are not expressly approved by HP may void the user's authority to operate the equipment.

Use of a shielded interface cable is required to comply with the Class B limits of Part 15 of FCC rules.

For further information, contact: Manager of Corporate Product Regulations, HP Inc., 1501 Page Mill Road, Palo Alto, CA 94304, USA.

This device complies with Part 15 of the FCC Rules. Operation is subject to the following two conditions: (1) this device may not cause harmful interference, and (2) this device must accept any interference received, including interference that may cause undesired operation.

VCCI statement (Japan)

この装置は、情報処理装置等電波障害自主規制協議会（VCCI）の基準に基づくクラスB情報技術装置です。この装置は、家庭環境で使用することを目的としていますが、この装置がラジオやテレビジョン受信機に近接して使用されると、受信障害を引き起こすことがあります。
取扱説明書に従って正しい取り扱いをして下さい。

Power cord instructions

Make sure your power source is adequate for the product voltage rating. The voltage rating is on the product label. The product uses either 100-240 Vac or 200-240 Vac and 50/60 Hz.

⚠ CAUTION: To prevent damage to the product, use only the power cord that is provided with the product.

Power cord statement (Japan)

製品には、同梱された電源コードをお使い下さい。
同梱された電源コードは、他の製品では使用出来ません。

EMC statement (Korea)

B급 기기 (가정용 방송통신기기)	이 기기는 가정용(B급)으로 전자파적합등록을 한 기기로서 주로 가정에서 사용하는 것을 목적으로 하며, 모든 지역에서 사용할 수 있습니다.
-----------------------	--

Visual display workplaces statement for Germany

Das Gerät ist nicht für die Benutzung im unmittelbaren Gesichtsfeld am Bildschirmarbeitsplatz vorgesehen. Um störende Reflexionen am Bildschirmarbeitsplatz zu vermeiden, darf dieses Produkt nicht im unmittelbaren Gesichtsfeld platziert werden.

European Union Regulatory Notice

- [European Union Regulatory Notice](#)
- [Wireless models only](#)

European Union Regulatory Notice



Products bearing the CE marking comply with one or more of the following EU Directives as may be applicable: Low Voltage Directive 2006/95/EC, EMC Directive 2004/108/EC, Ecodesign Directive 2009/125/EC, R&TTE Directive 1999/5/EC, RoHS Directive 2011/65/EU. Compliance with these directives is assessed using applicable European Harmonised Standards. The full Declaration of Conformity can be found at the following website: www.hp.com/go/certificates (Search with the product model name or its Regulatory Model Number (RMN), which may be found on the regulatory label.)

The point of contact for regulatory matters is:

HP GmbH, Dept./MS: HQ-TRE, Herrenberger Strasse 140, 71034 Boeblingen, GERMANY

Wireless models only

EMF

- This product meets international guidelines (ICNIRP) for exposure to radio frequency radiation.
If it incorporates a radio transmitting and receiving device that in normal use, a separation distance of 20 cm ensures that radio frequency exposure levels comply with EU requirements.

Wireless functionality in Europe

- This product is designed for use without restrictions in all EU countries plus Iceland, Liechtenstein, Norway and Switzerland.

Additional statements for wireless products

- [Exposure to radio frequency radiation](#)
- [Notice to users in Brazil](#)
- [Canadian statements](#)
- [Japan statement](#)
- [Notice to users in Korea](#)
- [Taiwan statement](#)
- [Mexico statement](#)

Exposure to radio frequency radiation

Exposure to radio frequency radiation

 **Caution** The radiated output power of this device is far below the FCC radio frequency exposure limits. Nevertheless, the device shall be used in such a manner that the potential for human contact during normal operation is minimized. This product and any attached external antenna, if supported, shall be placed in such a manner to minimize the potential for human contact during normal operation. In order to avoid the possibility of exceeding the FCC radio frequency exposure limits, human proximity to the antenna shall not be less than 20 cm (8 inches) during normal operation.

Notice to users in Brazil

Aviso aos usuários no Brasil

Este equipamento opera em caráter secundário, isto é, não tem direito à proteção contra interferência prejudicial, mesmo de estações do mesmo tipo, e não pode causar interferência a sistemas operando em caráter primário.

Canadian statements

Under Industry Canada regulations, this radio transmitter may only operate using an antenna of a type and maximum (or lesser) gain approved for the transmitter by Industry Canada. To reduce potential radio interference to other users, the antenna type and its gain should be so chosen that the equivalent isotropically radiated power (e.i.r.p.) is not more than that necessary for successful communication.

This device complies with Industry Canada licence-exempt RSS standard(s). Operation is subject to the following two conditions: (1) this device may not cause interference, and (2) this device must accept any interference, including interference that may cause undesired operation of the device.

 **WARNING!** Exposure to Radio Frequency Radiation The radiated output power of this device is below the Industry Canada radio frequency exposure limits. Nevertheless, the device should be used in such a manner that the potential for human contact is minimized during normal operation.

To avoid the possibility of exceeding the Industry Canada radio frequency exposure limits, human proximity to the antennas should not be less than 20 cm (8 inches).

Japan statement

この機器は技術基準適合証明又は工事設計認証を受けた無線設備を搭載しています。

Notice to users in Korea

해당 무선설비는 전파혼신 가능성이 있으므로 인명안전과 관련된 서비스는 할 수 없음

Taiwan statement

低功率電波輻射性電機管理辦法

第十二條 經型式認證合格之低功率射頻電機，非經許可，公司、商號或使用者均不得擅自變更頻率、加大功率或變更原設計之特性及功能。

第十四條 低功率射頻電機之使用不得影響飛航安全及干擾合法通信；經發現有干擾現象時，應立即停用，並改善至無干擾時方得繼續使用。前項合法通信，指依電信法規定作業之無線電通信。低功率射頻電機須忍受合法通信或工業、科學及醫療用電波輻射性電機設備之干擾。

Mexico statement

Aviso para los usuarios de México

La operación de este equipo está sujeta a las siguientes dos condiciones: (1) es posible que este equipo o dispositivo no cause interferencia perjudicial y (2) este equipo o dispositivo debe aceptar cualquier interferencia, incluyendo la que pueda causar su operación no deseada. Para saber el modelo de la tarjeta inalámbrica utilizada, revise la etiqueta regulatoria de la impresora.

Index

- A**
 - acoustic specifications 101
 - Alternative Letterhead Mode
 - input tray 44
 - anticounterfeit supplies 48
- B**
 - batteries included 105
 - bin, output
 - jams, clearing 72
- C**
 - cartridge levels, check 49
 - cartridges 50
 - check cartridge levels 49
 - non-HP 48
 - recycling 51, 104
 - storage 49
 - clean
 - touch screen 68
 - cleaning
 - printhead 67
 - color
 - adjusting 58
 - matching 59
 - printed vs. monitor 59
 - comparison, product models 1
 - connecting to a wireless network 13
 - connectivity
 - solving problems 81
 - USB 12
 - control panel
 - clean touch screen 68
 - cleaning page, printing 67
 - counterfeit supplies 48
 - customer support
 - online 89
- D**
 - default gateway, setting 19
 - defaults, restoring 67
 - disposal, end-of-life 105
 - duplex settings, changing 19
- E**
 - electrical specifications 101
 - embedded Web server
 - features 22
 - end-of-life disposal 105
 - environmental features 2
 - errors
 - software 85
- F**
 - factory-set defaults, restoring 67
 - features 2
 - firewall 13
 - fraud Web site 48
- G**
 - gateway, setting default 19
 - General Office setting 49
- H**
 - HP Customer Care 89
 - HP fraud website 48
 - HP Utility (OS X)
 - opening 32
 - HP Web Jetadmin 29
- I**
 - input tray
 - loading 40, 42, 43, 44, 45
 - installing
 - product on wired networks 13
 - IPv4 address 19
- J**
 - jams
 - causes of 69
 - locating 70
 - output bin, clearing 72
 - paper path, clearing 72
 - paper to avoid 46
 - Japanese VCCI statement 110
 - Jetadmin, HP Web 29
- K**
 - Korean EMC statement 110
- L**
 - left door
 - jams, clearing 72
 - link speed settings 19
 - loading envelopes
 - input tray 42, 43
 - loading letterhead 45
 - input tray 44
 - loading paper
 - input tray 40
 - loading preprinted forms 44
 - input tray 45
- M**
 - Mac
 - problems, troubleshooting 87
 - Macintosh
 - support 89
 - maintenance
 - check cartridge levels 49
 - managing network 18
 - matching colors 59
 - material restrictions 105
 - mercury-free product 105
 - model
 - comparison 1

models, feature overview 2

N

network

- password, changing 19
- password, setting 19
- settings, changing 18
- settings, viewing 18

networks

- default gateway 19
- HP Web Jetadmin 29
- IPv4 address 19
- subnet mask 19

networks, wired

- installing product 13

non-HP supplies 48

O

online support 89

OS X

- HP Utility 32

output bin

- jams, clearing 72

P

paper

- default size for tray 39
- jams 69
- selecting 46, 79

paper path

- jams, clearing 72

paper pickup problems

- solving 69

paper type

- changing 80

power

- consumption 101

print cartridges

- recycling 51, 104

print quality

- improving 79, 80

printer driver

- configuring wireless network 18

printer drivers

- choosing 80

printer software (OS X)

- opening 32

printer software (Windows)

- opening the printer software (Windows) 18

problem-solving

- no response 78
- slow response 79

product

- model comparison 1

product overview 2

R

recycling 2, 104

recycling supplies 51

reports

- event log 67
- network configuration page 67
- PCL font list 67
- PCL6 font list 67
- printer status report 66
- PS fonts list 67
- quality report 66

restoring factory-set defaults 67

S

settings

- factory-set defaults, restoring 67

software

- problems 85

solving

- network problems 82
- USB direct-connect problems 81

specifications

- electrical and acoustic 101

storing

- cartridges 49

subnet mask 19

supplies

- counterfeit 48
- non-HP 48
- recycling 51, 104

support

- online 89

T

TCP/IP

- manually configuring IPv4 parameters 19

technical support

- online 89

touch screen, clean 68

Tray 1

- jams, clearing 70

Tray 2

- jams, clearing 71

trays

- default paper size 39
- jams, clearing 71

troubleshooting

- checklist 65
- jams 69
- Mac problems 87
- network problems 82
- paper feed problems 69
- USB direct-connect problems 81

U

USB configuration 12

W

warranty

- product 90

Waste disposal 106

Web sites

- customer support 89
- HP Web Jetadmin, downloading 29
- Macintosh customer support 89

websites

- fraud reports 48

wireless network

- configuring with the setup wizard 14
- installing the driver 18

wireless network connection 13

Wireless Setup Wizard

- configuring wireless network 14